

LEDSetting V1.2

User Manual

Revision History

No.	Version	Date	Author	Description
1	1.0	2023.03.30	Chen Rui, Jiang Min	Initial release
2	1.2	2023.09.20	Jiang Min	Revisions & Updates

Colorlight Cloud Tech Ltd

Contents

1. Overview	1
1.1 Runtime Environment.....	1
1.2 Software Installation.....	1
2. Quick Start	3
2.1 Device Detection.....	3
2.2 Configure Sender.....	4
2.3 Receiver Parameters	4
2.4 Receiver Mapping.....	5
3. Main Interface	6
4. Device Information	10
5. Display Settings	13
6. Screen Configuration.....	17
6.1 Device Information.....	17
6.2 Sender Settings	18
6.2.1 Video Source.....	19
6.2.2 Control Area.....	26
6.2.3 Brightness & Color	26
6.2.4 Freeze & Black	27
6.2.5 Network	27
6.2.6 Art-Net.....	27
6.2.7 HDR.....	28
6.2.8 Precise Color Management.....	28
6.2.9 Other	29
6.3 Receiver Parameters	30
6.3.1 Basic Parameters	31

6.3.2 Driver & Decode IC	45
6.3.3 Gamma.....	46
6.3.4 Calibration	54
6.3.5 Display.....	61
6.3.6 Other	62
6.3.7 Intelligent Settings.....	63
6.3.8 Function Button	82
6.4 Connecting a Display.....	85
6.4.1 Standard	86
6.4.2 Complex.....	90
7. Test Tool	92
8. Pixel-by-pixel Calibration	102
8.1 Quick Operations.....	103
8.1.1 Brightness/Chroma Calibration.....	103
8.1.2 Gradient Adjustment	105
8.1.3 Deseam	106
8.2 Brightness Calibration	107
8.2.1 By Pixel.....	107
8.2.2 By Cabinet.....	116
8.2.3 By Module.....	119
8.2.4 Deseam	121
8.3 Chroma Calibration.....	123
8.4 Special Calibration	128
8.4.1 Double Calibration.....	128
8.4.2 Low Gray Compensation Calibration	130
8.4.3 Chip Low Brightness Calibration	131
8.4.4 Coefficient Backup.....	131
8.4.5 Sender Cascading Calibration.....	132
9. Multi-function Card.....	133

9.1 Sensor Information	133
9.2 Relay Control	134
9.3 Auto Brightness Adjust.....	136
9.4 Troubleshooting.....	138
10. Monitor.....	140
10.1 Toolbar	141
10.2 Monitor Preview Area.....	141
10.3 Monitor Setting.....	142
10.4 View History Exceptions and Email Log.....	145
11. Intelligent Module.....	146
11.1 Screen Connection.....	146
11.2 Basic Information.....	147
11.3 Electronic Label.....	148
12. Pixel-by-pixel Detection.....	150
13. Prestore Picture	151
13.1 Prestore Screen Capture.....	151
13.2 Picture Processing.....	153
14. Player Mode	154

1. Overview

LEDSetting is developed for the screen adjustment with full range of devices from Colorlight, which also support various screen driver IC, screen types, and screen testing. It allows for manual calibration of large LED screens and is compatible with correction data collected by other professional calibration devices.

1.1 Runtime Environment

Environment		Configuration
System supported		Windows
System version		Windows11, Windows10, Windows7, Windows Server
Recommended configuration	Processor	Intel Core i5, AMD FX-6350 or later
	Running memory	4GB RAM or more
	Graphics card	NVIDIA GeForce GT 730, ATI Radeon HD 7730 or later

1.2 Software Installation

Software Installation

Step 1: Download LEDVISION software from our Colorlight official website (V9.0 and later versions): <https://www.lednets.com/product/download/381>

Step 2: Double-click  LEDVISION_Setup.exe to begin setup wizard.

Step 3: Follow the setup wizard and check “I accept: Software agreements”. Then choose from Quick Installation or Custom Installation.

- Quick Installation

Click the **Quick Installation** button and the software will be installed to the path by default: C:\Program Files (x86)\ColorLight. As shown in Figure 1.2.1.



Fig 1.2.1 Quick installation

- Custom Installation

In the installation interface, click **Customize** to choose a path you desired for installation. Then click **Install** to continue, as shown in Figure 1.2.2.

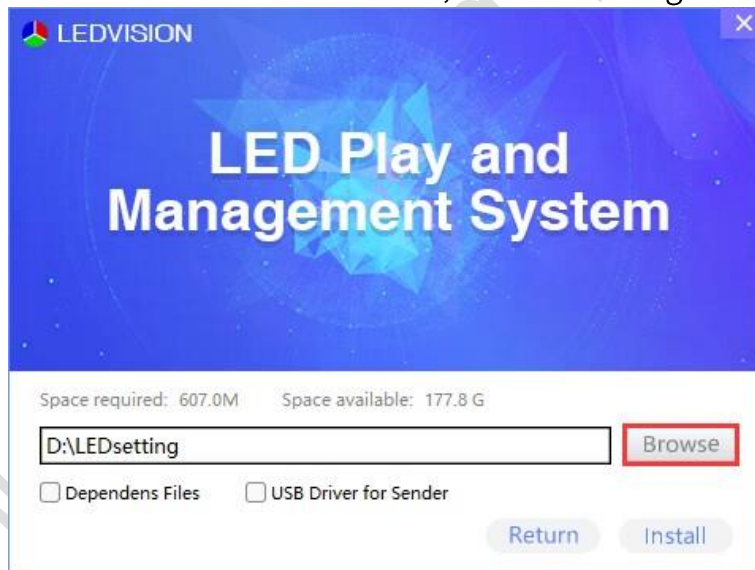

Fig 1.2.2 Custom installation

Step 4: Then, installation is completed as shown in Figure 1.2.3. After a successful installation, LEDVISION and LEDSetting shortcuts are generated on the desktop. LEDVISION is the playback software and LEDSetting is the control software.

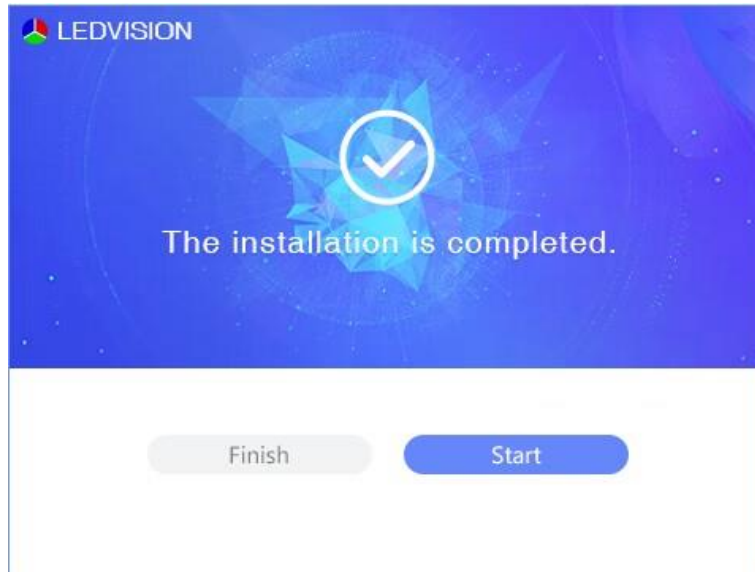



Fig 1.2.3 Installation completion

Software Uninstall

Right click the LEDSetting shortcut, then select **Open File Location** to open the installation path and double-click  **uninst.exe** to uninstall the LEDSetting software.

2. Quick Start

2.1 Device Detection

Step 1: Cabinets should be connected to the optical fiber transceiver via an Ethernet cable. The optical fiber transceiver and sender are connected with a fiber optic cable. Then connect the transmitter to the computer through a USB cable as shown in Figure 2.1.1.

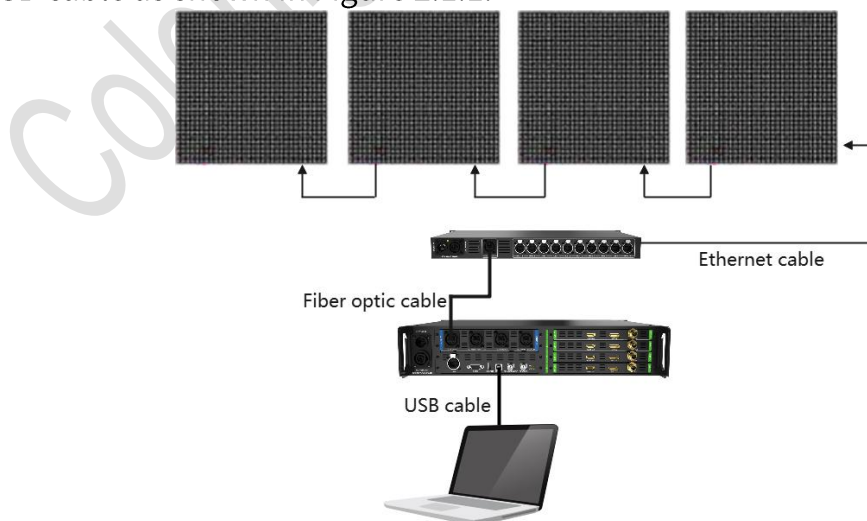

Fig 2.1.1 Device connection topology

Step 2: Open the LEDSetting software and double click **Screen Configuration**, then enter the authorization password to enter the **Screen Configuration - Device Information** interface.

Step 3: Click the **Detect Device** button for device information.

2.2 Configure Sender

Step 1: Click the **Sender Settings** button to switch to the **Sender Settings** tab.

Step 2: Modify the canvas size to make it consistent with the resolution of the input signal.

Step 3: Select the signal source to be displayed, then drag it to the canvas area to make it display normally, as shown in Figure 2.2.1.

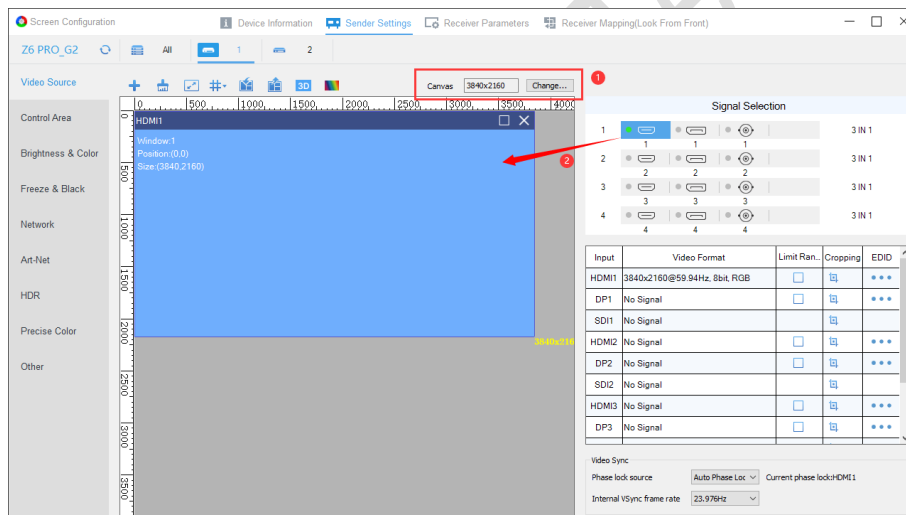

Fig 2.2.1 Video source settings

2.3 Receiver Parameters

Step 1: Click the **Receiver Parameters** button to switch to the **Receiver Parameters** tab.

Step 2: Configure the correct parameters of the receiver card through **Load** or **Intelligent Settings**.

Step 3: After the parameters are configured, click the **Save to Receivers** button to save the parameters on the receiver cards, as shown in Figure 2.3.1.

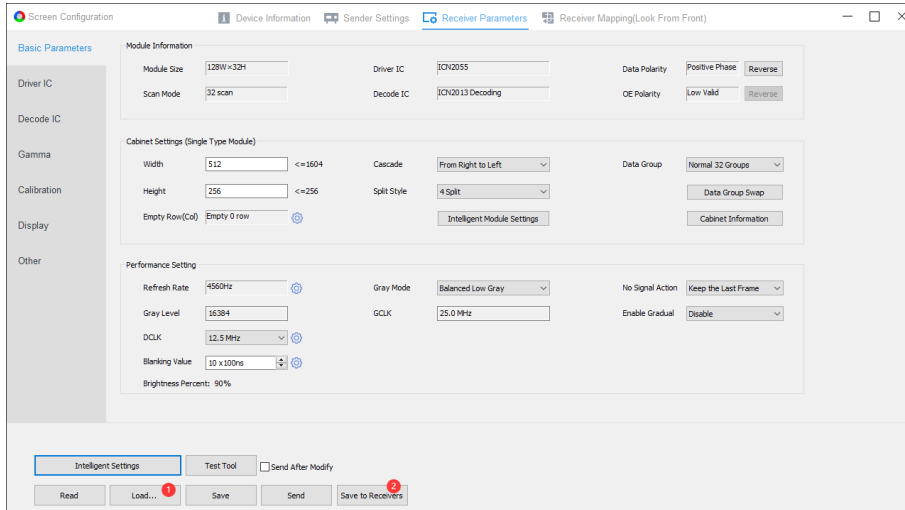

Fig 2.3.1 Save receiver parameters

2.4 Receiver Mapping

Step 1: Click the **Receiver Mapping** button to switch to the **Receiver Mapping** tab.

Step 2: According to the number and size of the cabinets, configure **Receiver(s) Count** and **Selected Rcv Information**.

Step 3: Select the corresponding Ethernet port and set the cabinet mapping according to the number of cabinets and the physical connections under each Ethernet port, as shown in Figure 2.4.1.

Step 4: Save the currently set mapping to the receiver card and light up the LED screen.

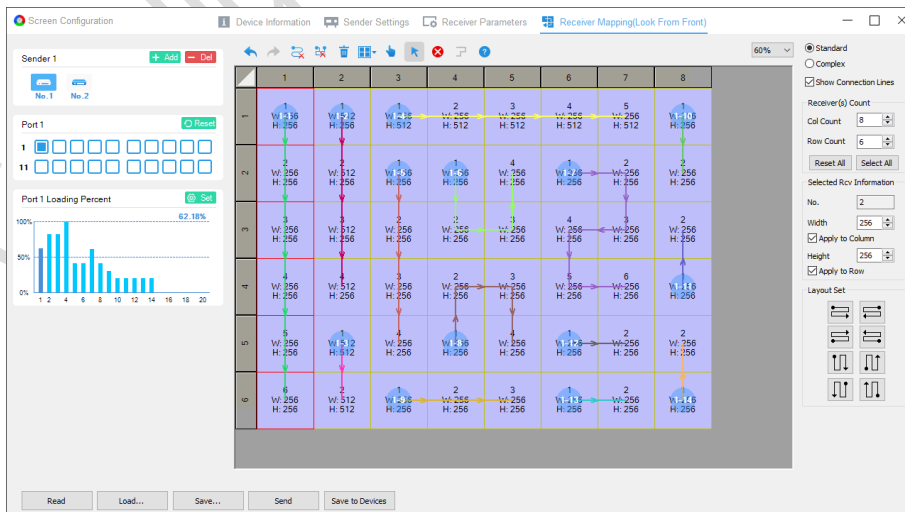

Fig 2.4.1 Cabinet mapping settings

3. Main Interface

The main interface consists of 3 parts: title bar, device bar and function entrance.

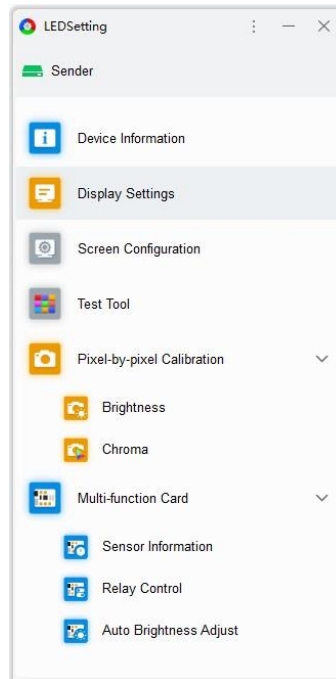

Fig 3.1 Main interface

Title Bar

The title bar includes software logo, software name, bubble tips, settings menu (language, software settings, software module, user manual, about), minimize button, and close button.

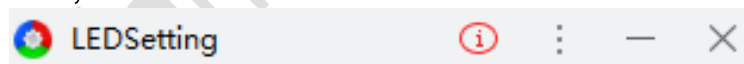

Fig 3.2 Title bar

- Bubble tips: A bubble will pop up when an error occurs with the sender, which can be viewed by hovering the mouse over the bubble.

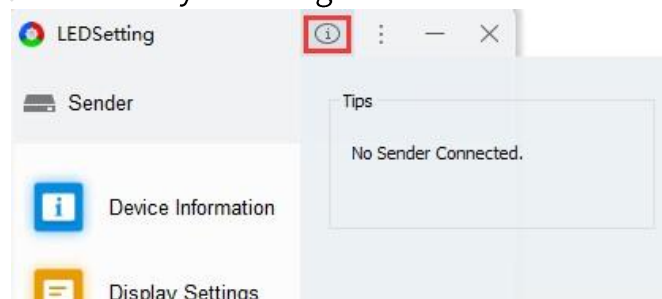

Fig 3.3 Bubble tips

A summary of the bubble tips for sender abnormality is shown in Table 3-1.

Table 3-1 Bubble tips summary

Abnormalities	Tips
Sender is offline.	No sender connected.
Sender brightness is 0.	Current sender brightness value is 0.
Sender enabled the screen blackout.	Blackout of the current LED screen is enabled.
Sender enabled the screen freeze.	Freeze of the current LED screen is enabled.
Sender enabled the black test mode.	The current sender is in screen blackout test mode.

- **Software Settings:** You can modify the theme and general settings of the software.
- **Software Theme:** Modify the theme color of the main interface. Support light, warm and dark colors.

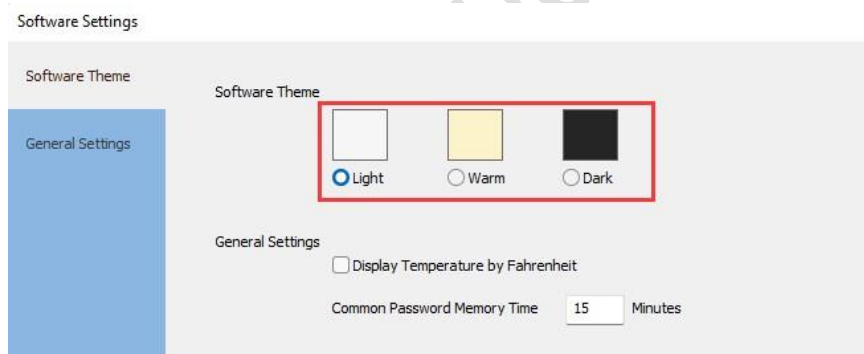

Fig 3.4 Software theme

- **General Settings:** Set the temperature display format and password memory time.

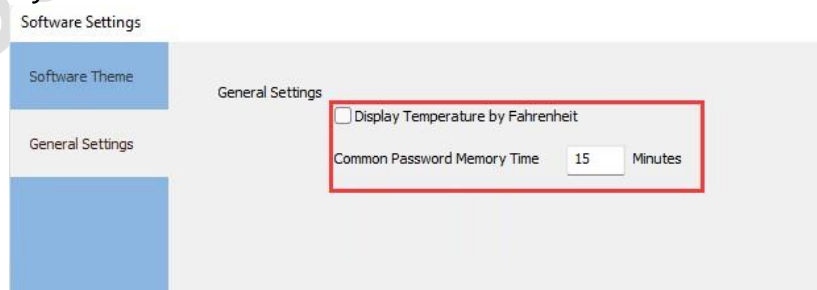

Fig 3.5 General settings

- ◆ **Display Temperature by Fahrenheit:** Check to display the temperature

in Fahrenheit (°F). Otherwise, the temperature is displayed in Celsius (°C).

- ◆ **Common Password Memory Time:** After entering the password, you don't need to input the authorization password again to operate the software within the memory time.
- **Software Module:** Configure the display status and order of the module entries in the main interface.

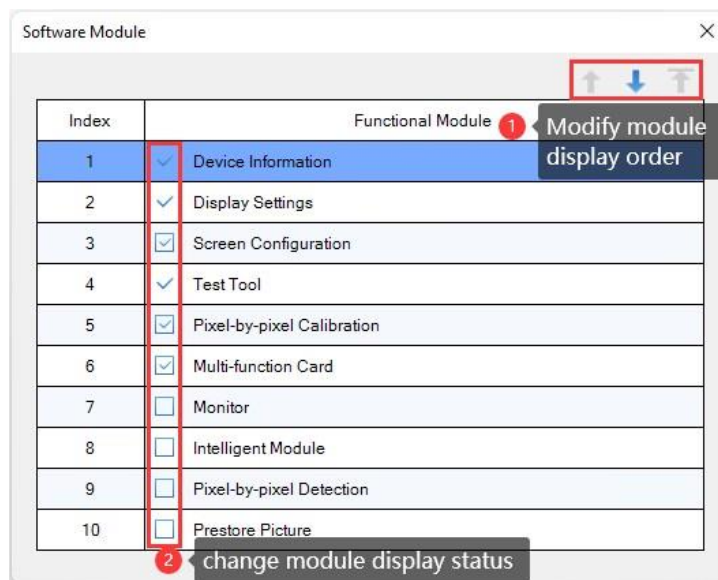





Fig 3.6 Software module settings

- **Module Order Adjustment:** Select a module and click  to move up the display order of modules. Click  to move down the modules and click  to top the modules.
- **Default Modules:** 6 modules are selected by default: **Device Information**, **Display Settings**, **Screen Configuration**, **Test Tool**, **Pixel-by-pixel Calibration** and **Multi-function Card**.
- **Module Display Status Modification:** Select the checkbox of a module to display the module in the main interface and deselect to hide.

Device Bar

- **Mode:** Display the current sending mode of the software. The **Sender** icon indicates sender mode, and the **Player** icon indicates player mode.
- **Device status**
- **Online status:** The current device is in normal connection, and the sender/player icon is shown in green.

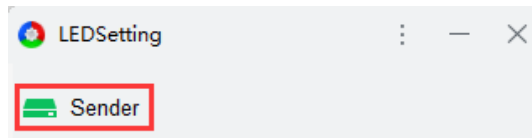

Fig 3.7 Online status

- Offline status: The current device has an abnormal connection, and the sender/player icon is displayed in gray.

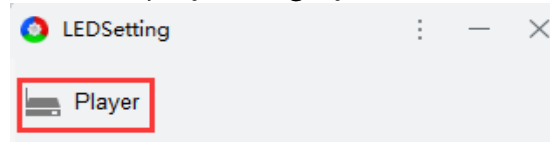

Fig 3.8 Offline status

Module Entries

- 6 common modules are displayed by default, and the display status of other module entries needs to be configured in **Software Module**.
- Click a module to open its secondary module or select it.
- Double-click a module to enter its corresponding function interface.
- If you switch the sending mode, the function entries will be changed accordingly.

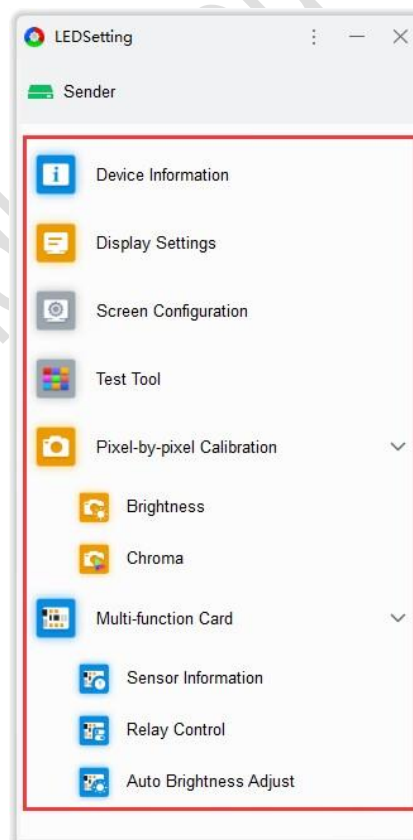

Fig 3.9 Function entries

4. Device Information

This feature is mainly used to detect sender and receiver card information, which are displayed on the left and right side of the panel respectively.

Type	Status/Count	Refresh	Port	Index	Type	Support Chip	Network Packets	Error Packets	Run Time	HUB Type
1 26 PRO_G2 1.60	128	[Refresh]	1	1	IP 1.52	MB1512,ICN2053,SUM2030	0	0	0:22:34	
> Fiber (Primary1 Backup1) (1-10)	128	[Refresh]	1	2	IP 1.52	MB1512,ICN2053,SUM2030	0	0	0:22:34	
> Fiber (Primary2 Backup2) (11-20)		[Refresh]	1	3	IP 1.52	MB1512,ICN2053,SUM2030	0	0	0:22:34	
2 26 PRO_G2 1.61	128	[Refresh]	1	4	IP 1.52	MB1512,ICN2053,SUM2030	0	0	0:22:34	
> Fiber (Primary1 Backup1) (1-10)	128	[Refresh]	1	5	IP 1.52	MB1512,ICN2053,SUM2030	0	0	0:22:34	
> Fiber (Primary2 Backup2) (11-20)		[Refresh]	1	6	IP 1.52	MB1512,ICN2053,SUM2030	0	0	0:22:34	
			1	7	IP 1.52	MB1512,ICN2053,SUM2030	0	0	0:22:34	
			1	8	IP 1.52	MB1512,ICN2053,SUM2030	0	0	0:22:34	
			1	9	IP 1.52	MB1512,ICN2053,SUM2030	0	0	0:22:34	
			1	10	IP 1.52	MB1512,ICN2053,SUM2030	0	0	0:22:34	
			1	11	IP 1.52	MB1512,ICN2053,SUM2030	0	0	0:22:34	
			1	12	IP 1.52	MB1512,ICN2053,SUM2030	0	0	0:22:34	
			1	13	IP 1.52	MB1512,ICN2053,SUM2030	0	0	0:22:34	
			1	14	IP 1.52	MB1512,ICN2053,SUM2030	0	0	0:22:34	
			1	15	IP 1.52	MB1512,ICN2053,SUM2030	0	0	0:22:34	
			1	16	IP 1.52	MB1512,ICN2053,SUM2030	0	0	0:22:34	
			1	17	IP 1.52	MB1512,ICN2053,SUM2030	0	0	0:22:34	
			1	18	IP 1.52	MB1512,ICN2053,SUM2030	0	0	0:22:34	
			1	19	IP 1.52	MB1512,ICN2053,SUM2030	0	0	0:22:34	
			1	20	IP 1.52	MB1512,ICN2053,SUM2030	0	0	0:22:34	

Fig 4.1 Device information interface

- **Detect Device:** Click **Detect Device** to detect all senders and receiver card information of selected senders.
- **Device Cascading:** When you want to cascade multiple senders, right-click the **Detect Device** button to show the **All Devices** and **Sender Only** options. Select **Senders Only** to display only sender information in the list.

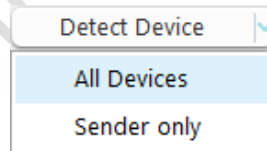

Fig 4.2 Detect senders

- **Reset Network Packet:** Click the **Reset Network Packet** button to reset the network packets and error packets of the receiver card. Right click **Reset Network Packet** to show the **Reset Network Packet** extension.

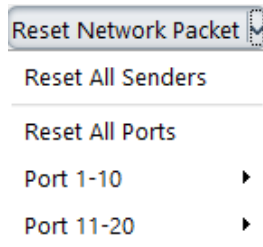

Fig 4.3 Reset network packets extension

- **Reset All Senders:** Reset the **Network Packets** and **Error Packets** for all

receiver cards.



- **Reset All Ports:** Reset the **Network Packets** and **Error Packets** of all receiver cards under the selected Senders.
- **Port:** Select a network port and reset the **Network Packets** and **Error Packets** of all receiver cards under this port.

Sender List

The Sender information bar displays the buttons of **Type**, **Status/Count**, and **Refresh**.

Type	Status/Count	Refresh
1 Z6 PRO_G2 1.60 > Fiber (Primary1 Backup1) (1-10) > Fiber (Primary2 Backup2) (11-20)	128	
2 Z6 PRO_G2 1.61 > Fiber (Primary1 Backup1) (1-10) > Fiber (Primary2 Backup2) (11-20)	128	

Fig 4.4 Sender list

- **Type:** It displays the index, type, and version of the sender.
- Click the Sender type button  to display the network ports under the sender.
- **Version Detail:** Hover mouse over the sender type to display , and click the button to open the dialog box of version details for the program version information.
- **Status/Count:** It shows the number of all receiver cards under the device. Network port icon and optical fiber transceiver icon show the connection status. Icons in green indicate normal connection and in gray indicate disconnection.
- **Refresh:** Hovering mouse over the sender, optical fiber transceiver, and network port, then  button will be displayed in the **Refresh** column.
- **Sender:** Click **Refresh** to re-detect all receiver cards under this sender.
- **Optical Fiber Transceiver:** Click **Refresh** to re-detect the receiver cards under the current optical optic transceiver.
- **Network Port:** Click **Refresh** to re-detect the receiver cards under the current network port.

Receiver Card List

The receiver card information column displays port, index, type, supported chips, number of network packets, number of error packets, run time, and HUB type.

Port	Index	Type	Support Chip	Network Packets	Error Packets	Run Time	HUB Type
1	1	i9 1.52	MBI5152,ICN2053,SUM2030	0	0	0:22:34	
1	2	i9 1.52	MBI5152,ICN2053,SUM2030	0	0	0:22:34	
1	3	i9 1.52	MBI5152,ICN2053,SUM2030	0	0	0:22:34	
1	4	i9 1.52	MBI5152,ICN2053,SUM2030	0	0	0:22:34	
1	5	i9 1.52	MBI5152,ICN2053,SUM2030	0	0	0:22:34	
1	6	i9 1.52	MBI5152,ICN2053,SUM2030	0	0	0:22:34	
1	7	i9 1.52	MBI5152,ICN2053,SUM2030	0	0	0:22:34	
1	8	i9 1.52	MBI5152,ICN2053,SUM2030	0	0	0:22:34	
1	9	i9 1.52	MBI5152,ICN2053,SUM2030	0	0	0:22:34	
1	10	i9 1.52	MBI5152,ICN2053,SUM2030	0	0	0:22:34	
1	11	i9 1.52	MBI5152,ICN2053,SUM2030	0	0	0:22:34	
1	12	i9 1.52	MBI5152,ICN2053,SUM2030	0	0	0:22:34	
1	13	i9 1.52	MBI5152,ICN2053,SUM2030	0	0	0:22:34	
1	14	i9 1.52	MBI5152,ICN2053,SUM2030	0	0	0:22:34	
1	15	i9 1.52	MBI5152,ICN2053,SUM2030	0	0	0:22:34	
1	16	i9 1.52	MBI5152,ICN2053,SUM2030	0	0	0:22:34	
1	17	i9 1.52	MBI5152,ICN2053,SUM2030	0	0	0:22:34	
1	18	i9 1.52	MBI5152,ICN2053,SUM2030	0	0	0:22:34	
1	19	i9 1.52	MBI5152,ICN2053,SUM2030	0	0	0:22:34	
1	20	i9 1.52	MBI5152,ICN2053,SUM2030	0	0	0:22:34	

Fig 4.5 Receiver card list

A list of receiver card information is shown in Table 4-1.

Table 4-1 Receiver card list information

Feature	Description
Port	Display the index of the network ports where the receiver cards are connected.
Index	Display the physical connection number of the receiver cards.
Type	Display the receiver card type and FPGA program version.
Support chip	Display the type of driver chip supported by the receiver card program.
Network packets	Display the number of network packets generated by the communication of receiver cards.
Error packets	Display the number of error packets generated by the communication of receiver cards.
Run time	Display the time the receiver card has been running continuously.
HUB type	Display the HUB type of the receiver cards.

5. Display Settings

Configure the sender parameters to adjust the LED screen display.

Brightness & Color

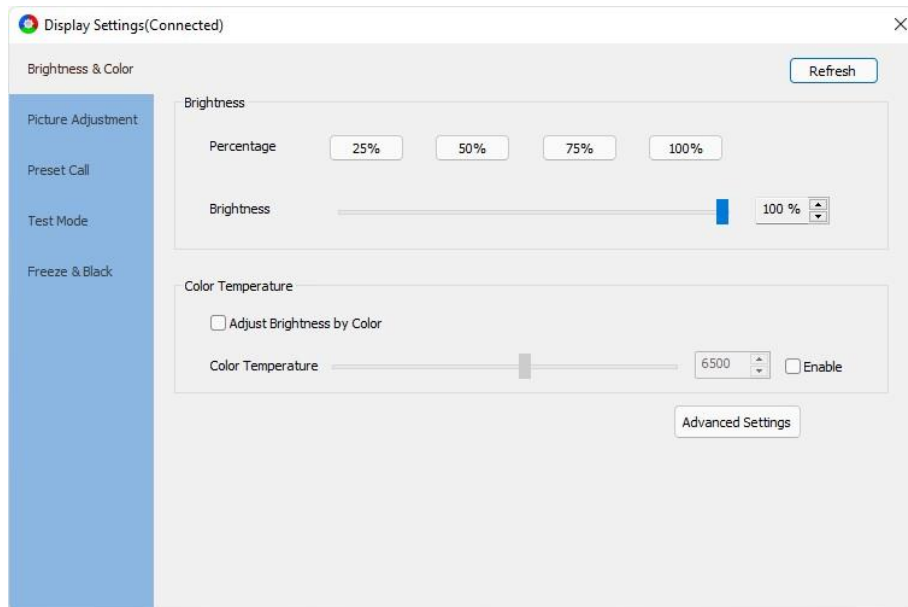



Fig 5.1 Brightness & Color

- **Brightness:** Configure the brightness parameters to adjust the LED screen brightness.
- **Percentage:** Quickly adjust the screen to the specified brightness.
- **Brightness:** Adjust the screen brightness by dragging the slider or clicking the spin button  with your mouse.
- **Color Temperature:** Configure color temperature parameters to adjust the color temperature of LED screen.
- **Adjust Brightness by Color:** Check to adjust the color temperature by red, green, and blue respectively.
- **Color Temperature:** Check to adjust the color temperature of the screen by dragging the slider or clicking the spin button  with your mouse.
- **Advanced Settings:** Click the **Advanced Settings** button to open the **Advanced Settings** dialog box.
- Adjust the brightness and color temperature for single or multiple devices.
- Use **Adjustment by Port** to adjust the brightness of each output port under the sender independently.

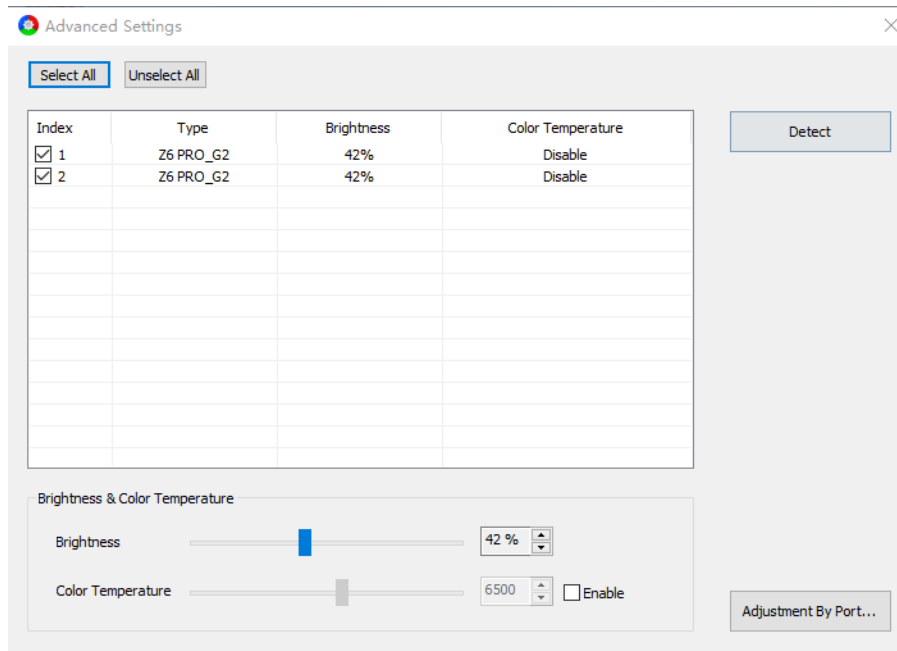

Fig 5.2 Advanced settings

- Select All: All devices will be checked in the list.
- Unselect All: No devices will be checked in the list.

The list items of **Advanced Settings** interface are described in Table 5-1 below.

Table 5-1 List items information

Item	Description
Index	The physical connection order in which the senders are connected.
Type	Display the sender and version.
Brightness	Display the brightness value of the sender.
Color Temperature	Before the color temperature is enabled, Disable is displayed; after it is enabled, the color temperature value of the sender is displayed.

- Detect: Detect all senders.
- Brightness and Color Temperature Adjustment: Adjust the brightness value and color temperature value of the selected sender.
- Adjustment by Port: After grouping the ports, adjust the brightness of the groups independently.

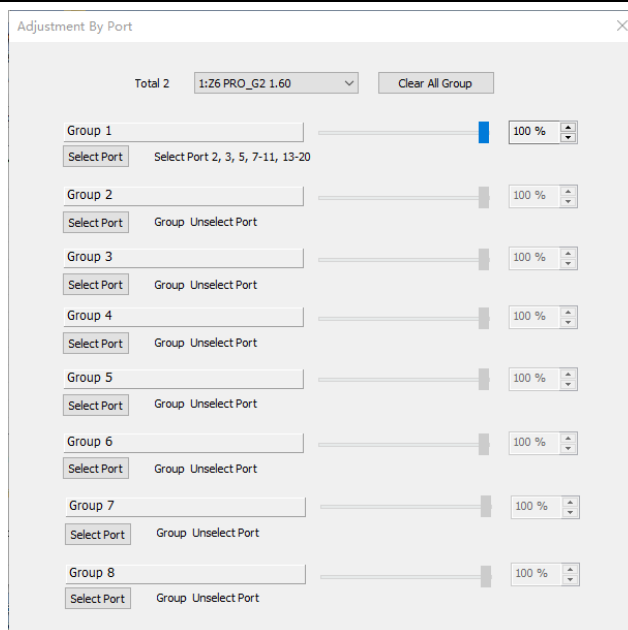



Fig 5.3 Adjust brightness by port

Image Adjustment

Check to adjust the **Hue**, **Saturation**, **Brightness Compensation** and **Contrast** parameters by dragging the slider with the mouse or clicking the spin button  or modifying the values in the input box.

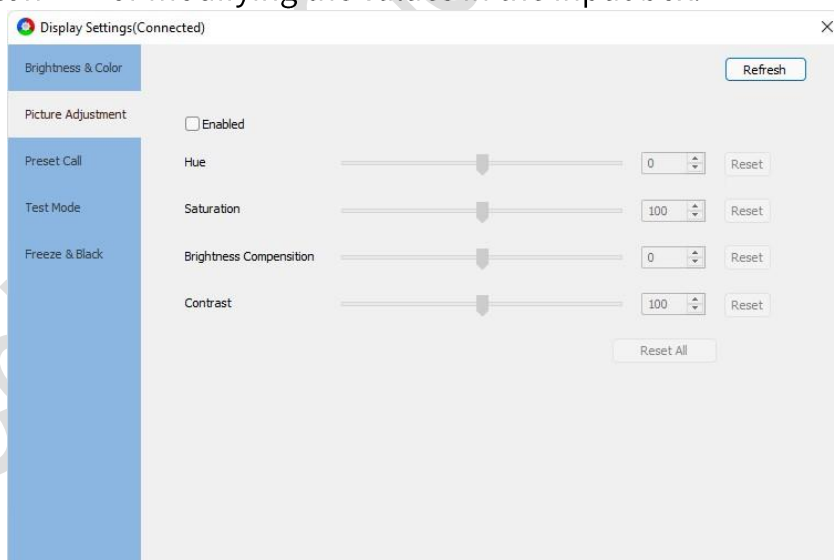

Fig 5.4 Image adjustment

- **Reset button:** The corresponding parameter is reset to its default value.
- **Reset All button:** All parameters are reset to their default values.

Preset

Click to call the presets of the sender.

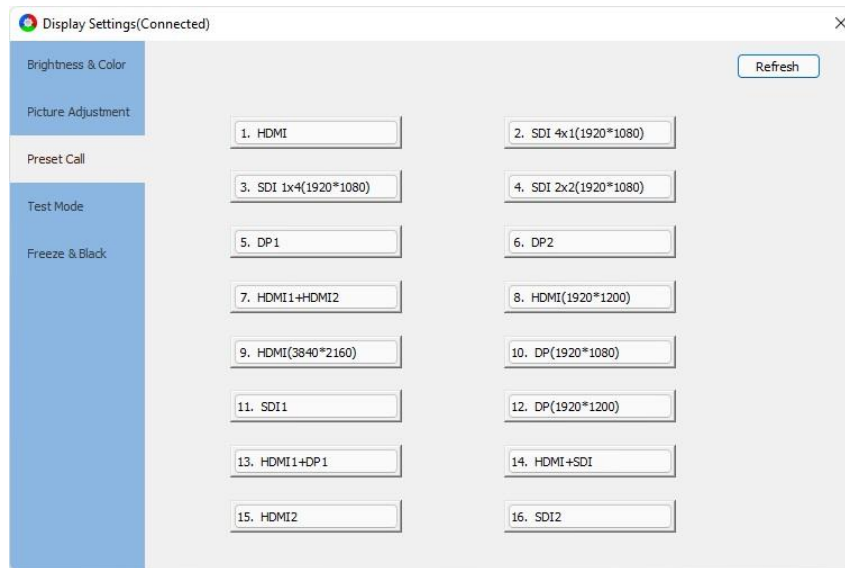

Fig 5.5 Call the presets

Test Mode

You can set different test modes according to your needs. View the display effect of LED screen through the test modes to test and diagnose the display.

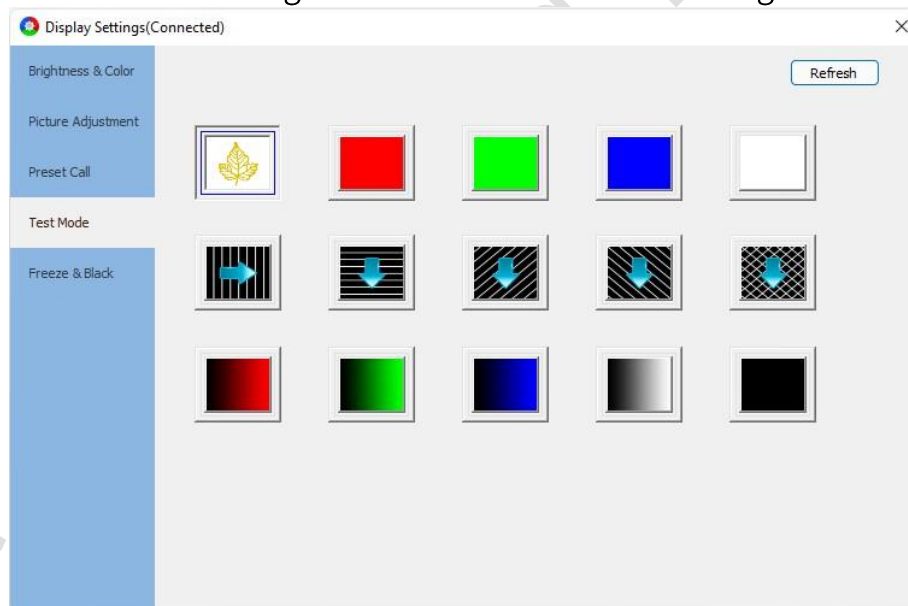

Fig 5.6 Test mode

Freeze & Black

Control the status of senders output screen to freeze or black screen.

- **Freeze:** Freeze is enabled to display the last frame.
- **Black:** Click **Black** to blackout LED display.

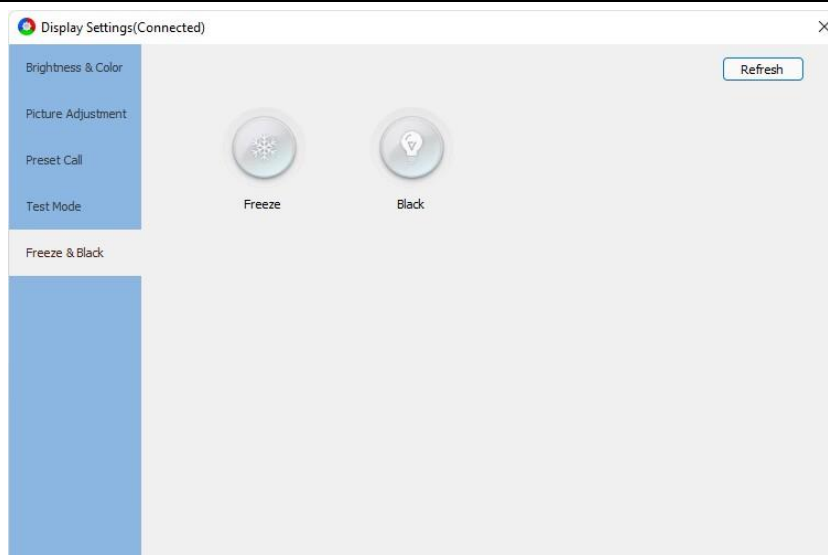

Fig 5.7 Freeze & Black

6. Screen Configuration

Screen configuration interface includes 4 tabs: **Device Information**, **Sender Settings**, **Receiver Parameters**, and **Receiver Mapping**.

6.1 Device Information

Display information about all devices connected.

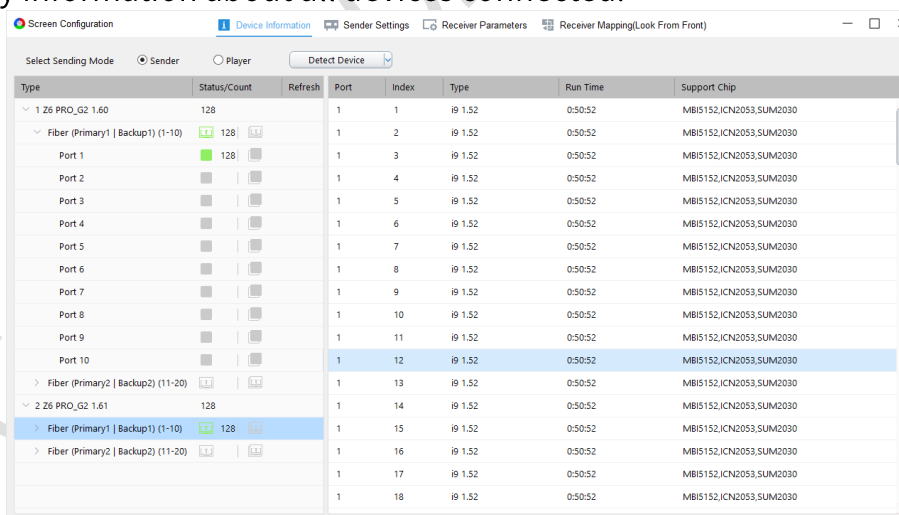

Type	Status/Count	Refresh	Port	Index	Type	Run Time	Support Chip
1 Z6 PRO_G2 1.60	128		1	1	ip 1.52	0:50:52	MBIS152,ICN2053,SUM2030
Fiber (Primary1 Backup1) (1-10)	128		1	2	ip 1.52	0:50:52	MBIS152,ICN2053,SUM2030
Port 1	128		1	3	ip 1.52	0:50:52	MBIS152,ICN2053,SUM2030
Port 2			1	4	ip 1.52	0:50:52	MBIS152,ICN2053,SUM2030
Port 3			1	5	ip 1.52	0:50:52	MBIS152,ICN2053,SUM2030
Port 4			1	6	ip 1.52	0:50:52	MBIS152,ICN2053,SUM2030
Port 5			1	7	ip 1.52	0:50:52	MBIS152,ICN2053,SUM2030
Port 6			1	8	ip 1.52	0:50:52	MBIS152,ICN2053,SUM2030
Port 7			1	9	ip 1.52	0:50:52	MBIS152,ICN2053,SUM2030
Port 8			1	10	ip 1.52	0:50:52	MBIS152,ICN2053,SUM2030
Port 9			1	11	ip 1.52	0:50:52	MBIS152,ICN2053,SUM2030
Port 10			1	12	ip 1.52	0:50:52	MBIS152,ICN2053,SUM2030
Fiber (Primary2 Backup2) (11-20)			1	13	ip 1.52	0:50:52	MBIS152,ICN2053,SUM2030
2 Z6 PRO_G2 1.61	128		1	14	ip 1.52	0:50:52	MBIS152,ICN2053,SUM2030
Fiber (Primary1 Backup1) (1-10)	128		1	15	ip 1.52	0:50:52	MBIS152,ICN2053,SUM2030
Fiber (Primary2 Backup2) (11-20)			1	16	ip 1.52	0:50:52	MBIS152,ICN2053,SUM2030
Fiber (Primary2 Backup2) (11-20)			1	17	ip 1.52	0:50:52	MBIS152,ICN2053,SUM2030
Fiber (Primary2 Backup2) (11-20)			1	18	ip 1.52	0:50:52	MBIS152,ICN2053,SUM2030

Fig 6.1.1 Device information

- **Sender Mode:** Detect and control the sender.
- **Player Mode:** Detect and control the player.
- **Detect Device:** Click the **Detect Device** button to show the connected device information in the list.

- List: The left side shows the sender/player information, and the right side shows the receiver card information. For more details, please refer to Chapter 4.2 of the manual.

6.2 Sender Settings

Set up the connected sender. You can simulate the device when it is not connected and view the simulation interface of the device.

The sender settings interface is divided into two parts: device bar and function menu.

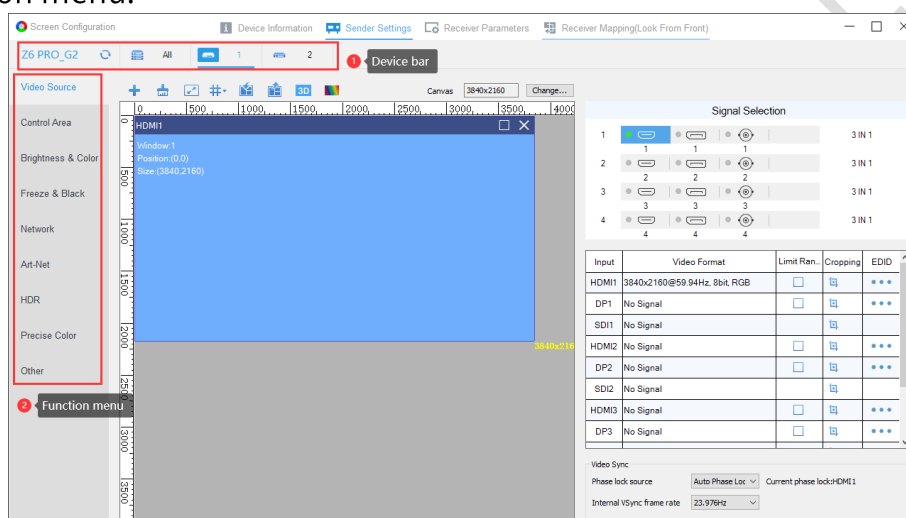



Fig 6.2.1 Sender settings

- Device bar: It displays the device type and index. Switch between indexes to configure different devices individually. When cascading multiple devices, switch to the **All** tab to configure all devices simultaneously.
- **All**: It includes 4 function menus - **Video Source**, **Brightness & Color**, **Freeze & Black**, and **Other**. The actual menus available may vary depending on the device.
- ◆ **Video Source**: The left side shows the signal window of the device, while the right side shows the device's preset list.
- ◆ **Brightness & Color**, **Freeze & Black**, and **Other**: These 3 items display information of the first device correspondingly. Any configuration will apply to all cascaded devices in real time.

- : Click to re-detect senders and refresh the **Sender Settings** interface.
- **Function menu**: It displays the functions supported by the connected devices. Here, we take Z6PRO_G2 as an example.

6.2.1 Video Source

The video source setup interface is divided into a toolbar, canvas area, and right panel.

Toolbar

The toolbar contains **Add Window**, **Delete All Window(s)**, **Set Window Size**, **Split Line**, **Save As Preset**, **Preset Management**, **3D Settings**, **Picture Adjustment**, and **Change (Canvas Size)**.



Fig 6.2.1.1 Toolbar



- **Add Window**: Click the  button to add a signal window to the canvas area.



Fig 6.2.1.2 Add signal window

- **Delete All Window(s)**: Click the  button to empty all signal windows in the canvas area.
- **Set Window Size**: Click the  button to pop up the **Set Window Size** window to set the starting point (X & Y coordinates), **Width** and **Height** for the selected signal window.

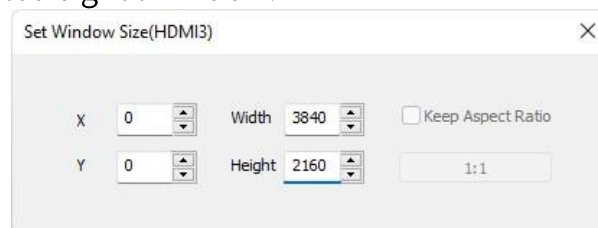



Fig 6.2.1.3 Set window size

- Split Line: It is used to guide the layout of signal windows. Click  to show the drop-down menu, then you can add, modify, or delete the split lines.

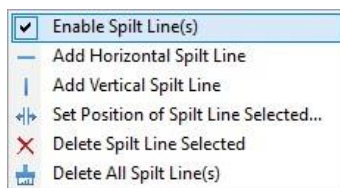



Fig 6.2.1.4 Set split line

The split line functions are described in detail in Table 6.2.1-1.

Table 6.2.1-1 Split line functions

Feature	Description
Enable Split Line(s)	When checked, the split lines are shown; when unchecked, the split lines are hidden.
Add Horizontal Split Line	When selected, you can add horizontal split lines to the canvas.
Add Vertical Split Line	When selected, you can add vertical split lines to the canvas.
Set Position of Split Line Selected	Modify the position of the selected split line.
Delete Split Line Selected	Delete the selected split lines.
Delete All Split Line(s)	Delete all split lines in the canvas.

- Save As Preset: Click  to open the dialog box and save the preset scene to the sender.

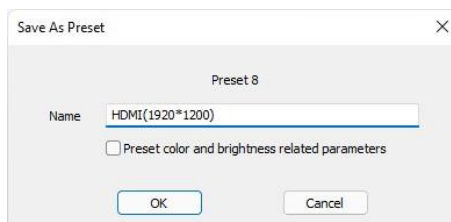

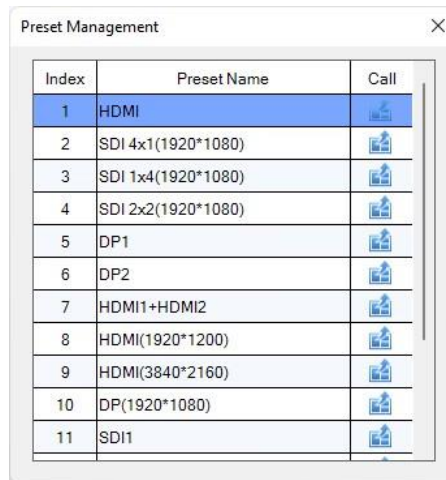

Fig 6.2.1.5 Save as preset

- Preset Management: Click  to open the **Preset Management** window, then click  to load preset parameters.











Index	Preset Name	Call
1	HDMI	
2	SDI 4x1(1920*1080)	
3	SDI 1x4(1920*1080)	
4	SDI 2x2(1920*1080)	
5	DP1	
6	DP2	
7	HDMI1+HDMI2	
8	HDMI(1920*1200)	
9	HDMI(3840*2160)	
10	DP(1920*1080)	
11	SDI1	

Fig 6.2.1.6 Preset management

- 3D Settings: Click the  button to enter the 3D settings interface. After enabling 3D, it can make the output image more three-dimensional and realistic. However, the total load capacity is reduced by half.

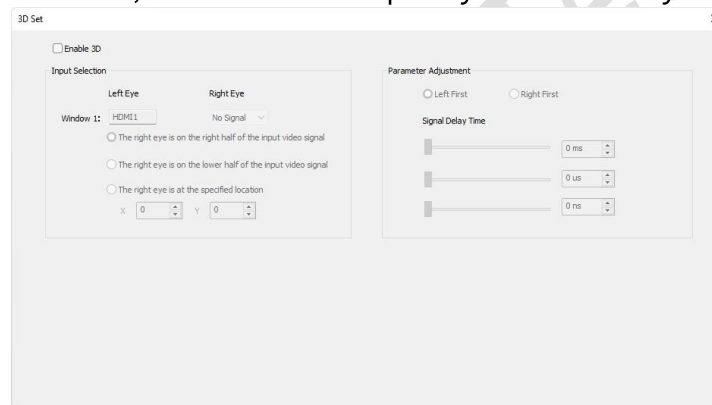



Fig 6.2.1.7 3D settings

- Picture Adjustment: Click  to open the **Picture Adjustment** dialog box, then you can adjust the screen display effect by adjusting the parameters after enabling this feature.

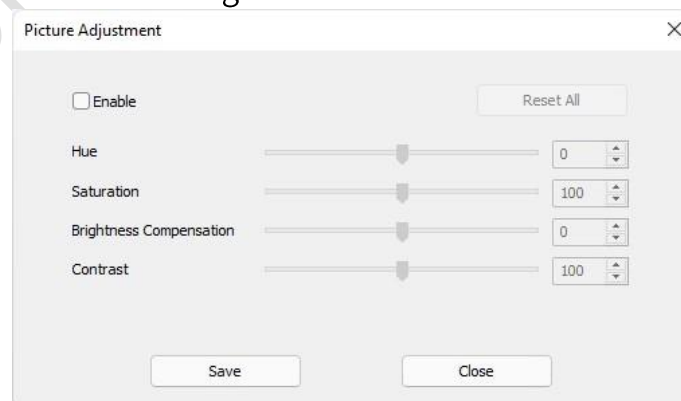

Fig 6.2.1.8 Picture adjustment

- Change (Canvas Size): The display box shows the current size of the canvas. Click the **Change** button to change the canvas size.

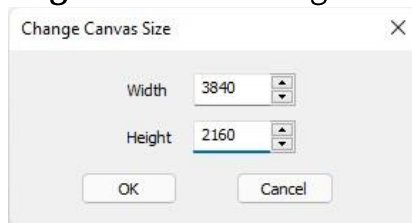

Fig 6.2.1.9 Change canvas size

Right Panel

The right panel is divided into 3 sections: **Signal Selection**, Signal List, and Video Sync.

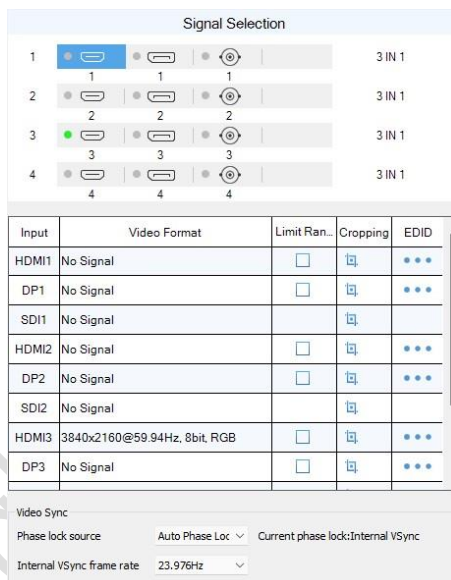

Fig 6.2.1.10 Right panel

Signal Selection

It is used for adding and switching the signal windows, displaying the board index, interface type, and board type in sequence.

- Board index: Display the physical location index of the board.
- Interface type: Display all interfaces of the board.
- Interface status: When the indicator is green or gray, it means the signal is connected or unconnected respectively.
- Board type: Display the board type. It shows **No Connect** when no board is inserted.



Fig 6.2.1.11 Board type and connection status

- Add Signal Window: Drag the board interface into the canvas area to add a signal window.

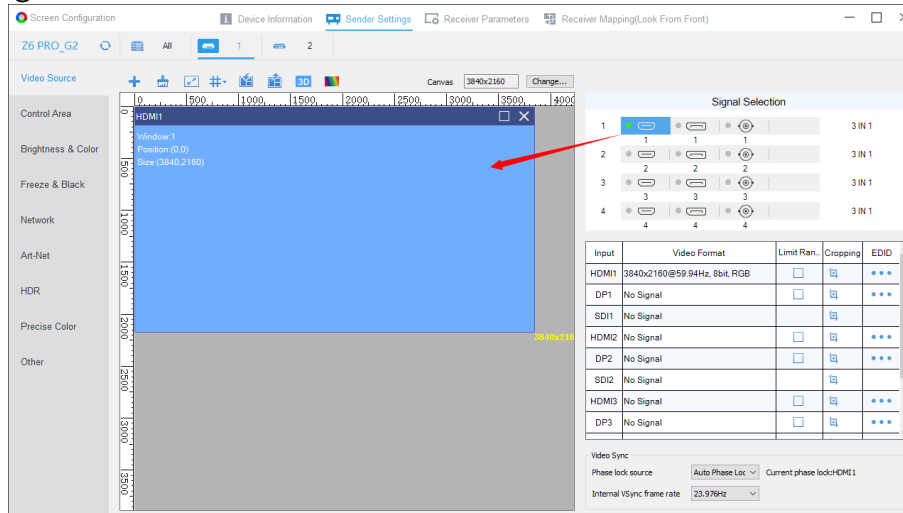

Fig 6.2.1.12 Add and switch a signal window

Signal List

It represents device interface information, including **Input**, **Video Format**, **Limit Range to Full Range**, **Cropping**, and **EDID**.

- **Input:** Shows the signal interface type.
- **Video format:** Contains resolution @ frame rate, color depth, and color model.
- **Limit Range to Full Range:** When enabled, you can change the color depth of the input signal.
- **Cropping:** Click to open the **Cropping** dialog box. After enabled, you can set the size and position of the cropping area by dragging the dashed box with the mouse or modifying the cropping information.

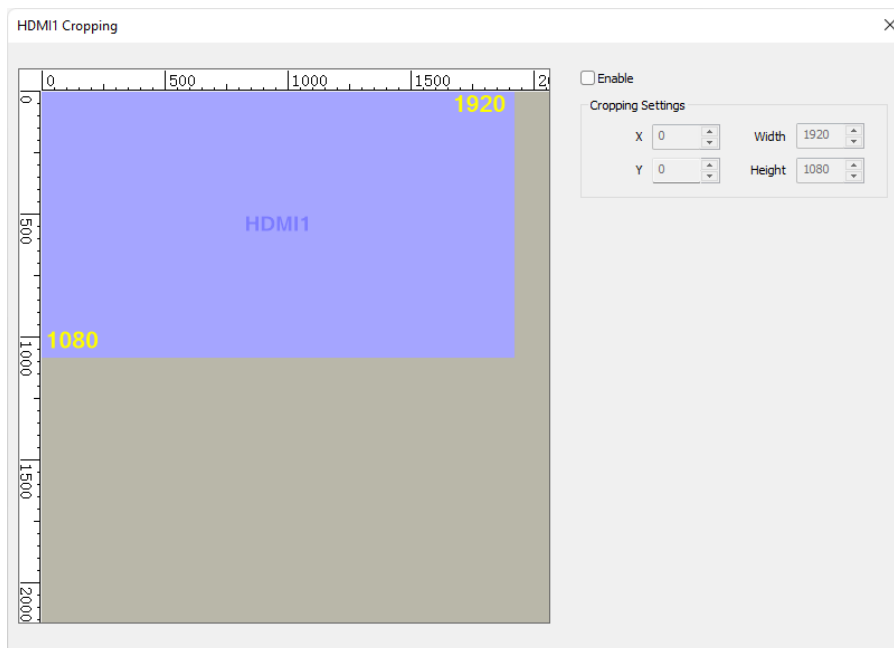

Fig 6.2.1.13 Signal cropping

- ⋮ EDID: Click ⋮ to open the EDID Settings dialog box for preset selection or resolution customization.

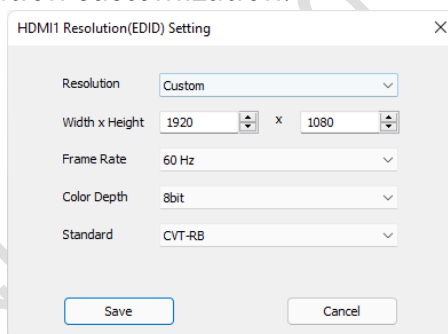

Fig 6.2.1.14 EDID settings

Video Sync

Synchronize the frame rate of the input signals. The frame rate of the LED display will be shown according to **Current Phase Lock**.

- Phase lock source: Select the **Phase Lock Source** to synchronize the frame rate of the input signals with the frame rate of the **Current Phase Lock** signal.
- Internal VSync frame rate: Modify the frame rate of **Internal VSync** signal.

Canvas Area

Canvas area displays input signal layout and signal size. It also supports dragging the signal window by mouse to change the position and size of the

window.

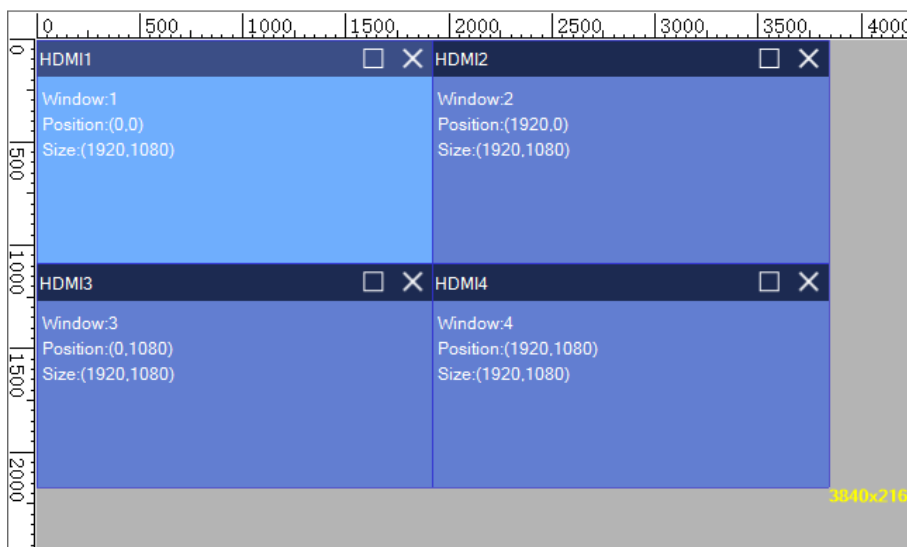

Fig 6.2.1.15 Canvas area

Right-click on the signal window to show the context menu.

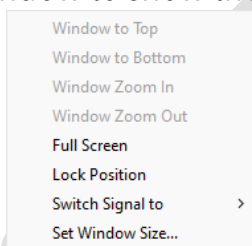

Fig 6.2.1.16 Context menu

The detailed function description of the context menu is shown in Table 6.2.1-2.

Table 6.2.1-2 Context menu function

Feature	Description
Window to Top	The selected window layer will be brought to front.
Window to Bottom	The selected window layer will be sent to back.
Window Zoom In/Out	Zoom in the window to spread it over the split line area. Zoom out the window to restore the window size.
Full Screen	Spread the window over the canvas area.
Lock Position	After locking, the window size and position cannot be modified.
Switch Signal to	Replace the selected window signal.
Set Window Size	Modify the window size and position.

6.2.2 Control Area

This feature is applied to modify the network port control area, which includes view area and list area.

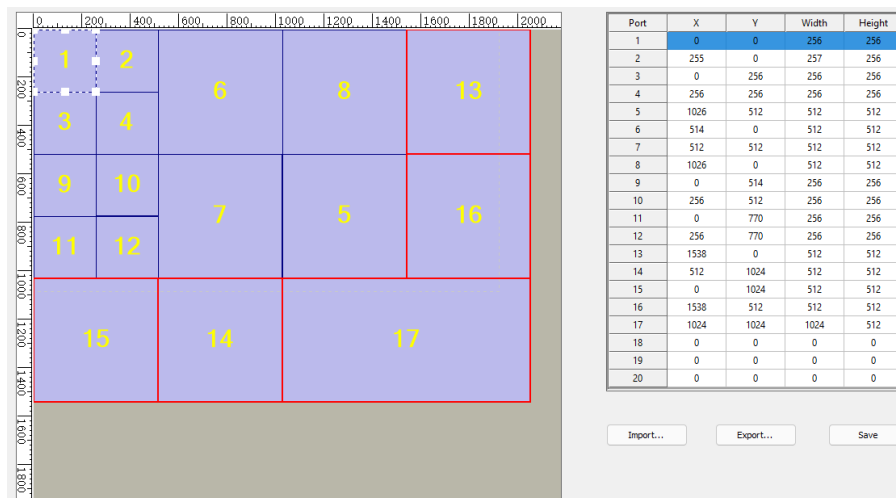

Fig 6.2.2.1 Control area

- View area: It graphically displays the network port control area. You can change the position and size of the control area by drag-and-drop operation.
- List area: It shows the position and size of the network port control area. You can modify the position and size of the control area by modifying the input box parameter.
- Import: Import the local parameter file.
- Export: Export the parameters of network port control area to a local file.
- Save: Save the parameters of network port control area to the sender.

6.2.3 Brightness & Color

Change the brightness and color temperature of the sender to adjust the LED display effect.

- Brightness: Adjust the brightness of LED display.
- Abnormal tips: When the brightness is 0, a pop-up tip will be displayed at the menu bar.

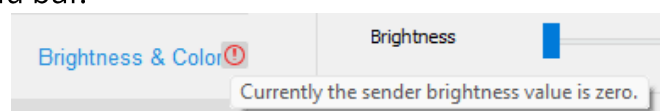

Fig 6.2.3.1 Abnormal tips

- Color temperature: Change the color temperature parameter to adjust

the color temperature of LED display.

6.2.4 Freeze & Black

The output screen from the sender is changed to a freeze or black screen.

- Freeze: Enable **Freeze** to display the LED screen at the last frame. A prompt will pop up at the menu bar.
- Black: Enable **Black** will blackout the LED screen. You will be prompted at the menu bar.

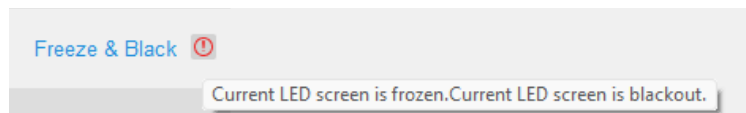

Fig 6.2.4.1 Freeze & Black tips

6.2.5 Network

Set the IP address of the sender.

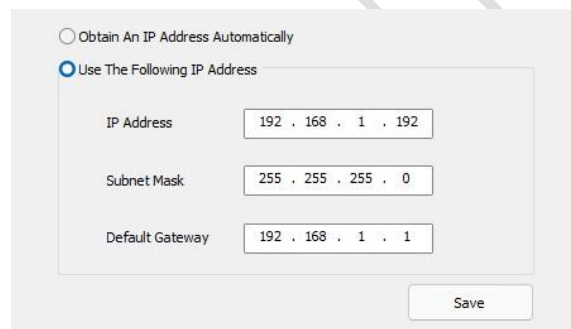
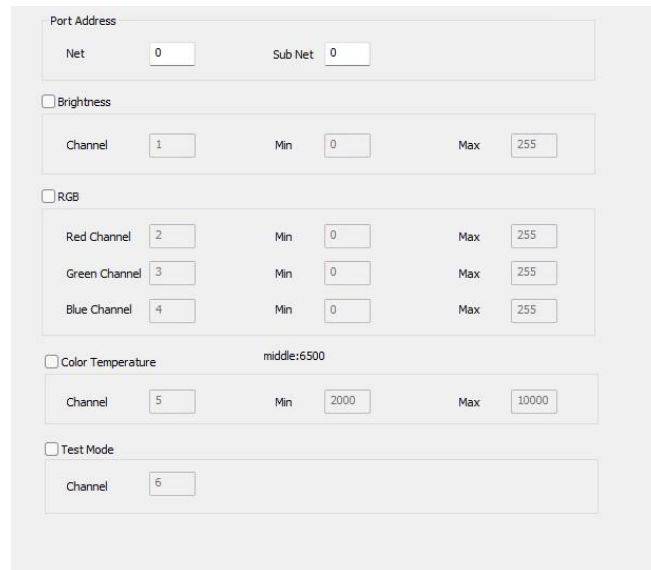

Fig 6.2.5.1 Network settings

- Obtain an IP address automatically: Use the IP address assigned by the DHCP server.
- Use the following IP address: Set the **IP Address**, **Subnet Mask**, and **Default Gateway** of the sender.

6.2.6 Art-Net

The Art-Net feature needs to be used cooperatively with a console.



The screenshot shows the Art-Net settings interface. It includes a 'Port Address' section with 'Net' and 'Sub Net' fields, both set to 0. Below this are several sections, each with a checkbox and a 'Channel' field:

- Brightness:** Channel 1, Min 0, Max 255.
- RGB:** Red Channel 2, Min 0, Max 255; Green Channel 3, Min 0, Max 255; Blue Channel 4, Min 0, Max 255.
- Color Temperature:** middle:6500, Channel 5, Min 2000, Max 10000.
- Test Mode:** Channel 6.

Fig 6.2.6.1 Art-Net settings

6.2.7 HDR

HDR (High Dynamic Range) image provides a higher dynamic range and more image details.



The screenshot shows the HDR Options interface. It features a group box titled 'HDR Options' containing six radio button options:

- Off
- Auto
- Forced to HDR10(Rec.2020)
- Forced to HLG(Rec.2020)
- Forced to HLG(DCI-P3)
- Forced to HLG(Rec.709)

 To the right of the group box is a checkbox labeled 'Enable Dynamic Calibration For HDR'.

Fig 6.2.7.1 HDR

6.2.8 Precise Color Management

You can modify the color and brightness information, as well as color space according to needs. When HDR dynamic calibration is enabled, there will be a **Before Calibration** tab added.

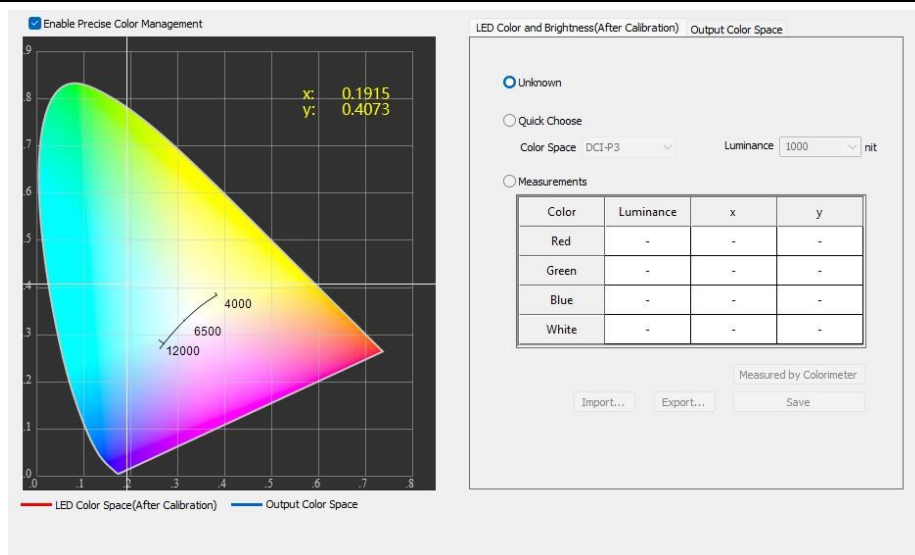

Fig 6.2.8.1 Precise color management

6.2.9 Other

Configure **Advanced Parameters**, **Advanced Functions**, and **Test Mode** for the sender.

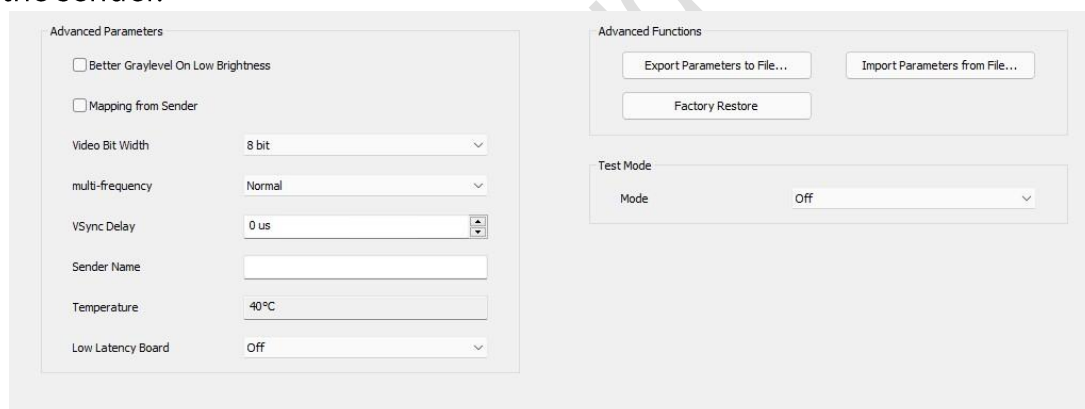

Fig 6.2.9.1 Other settings

Advanced Parameters

- Better graylevel on low brightness: When selected, this function can optimize the screen display effect under low brightness conditions.
- Mapping from sender: When selected, the mapping from the sender will be applied.
- Video bit width: Adjust the color depth from the sender.
- Multi-frequency: Multiply the frame rate of the input signal.
- VSync delay: Adjust the delay time of the Vsync signal.

- Sender name: Modify the name displayed on the front panel of the sender.
- Temperature: Display the sender temperature.
- Low latency board: Reduce the delay time of video signal from the board.

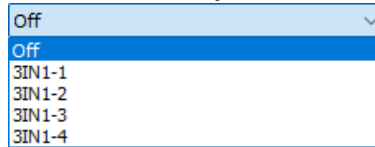

Fig 6.2.9.2 Low latency board

Advanced Functions

- Export parameters to file: Export the sender parameters to a local file.
- Import parameters from file: Import a local parameter file to the sender.
- Factory restore: Reset the sender parameters.

Test Mode

You can set different test modes according to your needs and view the display effect of LED screen with test modes to test and diagnose the screen.

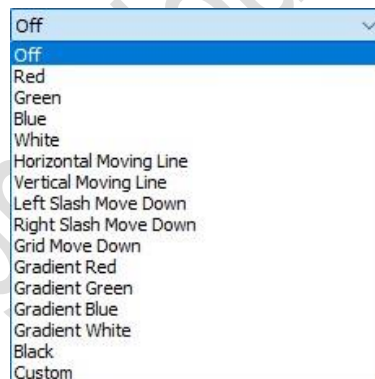

Fig 6.2.9.3 Test modes

- Abnormal tips: Select the black test mode and you will be prompted at the menu bar.

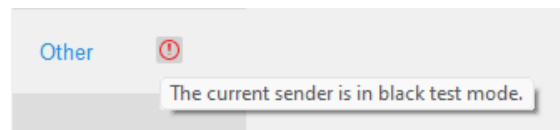

Fig 6.2.9.4 Test modes tips

6.3 Receiver Parameters

Select the Receiver Parameters tab in the screen configuration interface to

set LED display parameters, including basic parameters, driver IC, decode IC, Gamma, calibration, display, and other settings.

6.3.1 Basic Parameters

The basic parameters of the receiver card can be configured, including **Module Information**, **Cabinet Settings**, and **Performance Setting**.

Depending on the cabinet structure, the basic parameters of **Module Information** and **Cabinet Settings** can be different. Here, we take the chip set ICN2055 + ICN2013 as an example.

Module Information (Single Type Module)

The module information section displays the basic information of the module.



Fig 6.3.1.1 Module information (single type module)

Function description of module information is shown in Table 6.3.1-1.

Table 6.3.1-1 Functional description of module information

Parameters	Description
Module size	Show the width and height of the module.
Scan mode	Show the scans of the module.
Driver IC	Show the driver IC of the module.
Decode IC	Show the decode IC of the module.
Data polarity	Set the data polarity of the module.
OE polarity	Set the OE polarity of the module.

Cabinet Settings (Single Type Module)

In this section, the basic parameters of the cabinets can be configured.

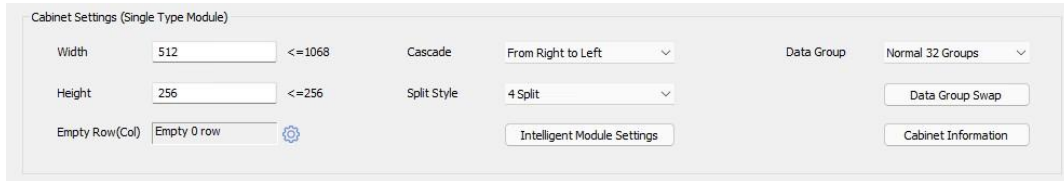

Fig 6.3.1.2 Cabinet settings (single type module)

- Width, Height: Set the width and height of the cabinets.
- Cascade: Modify the image of cascade direction displayed on the LED screen.

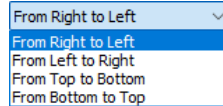

Fig 6.3.1.3 Cascade

- Split style: Increase the bandwidth by reducing the load height of the receiver card.

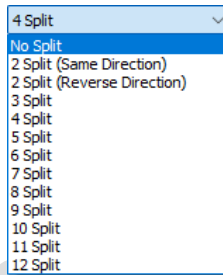

Fig 6.3.1.4 Split style

- Data group: Modify the number of data groups from the receiver card.

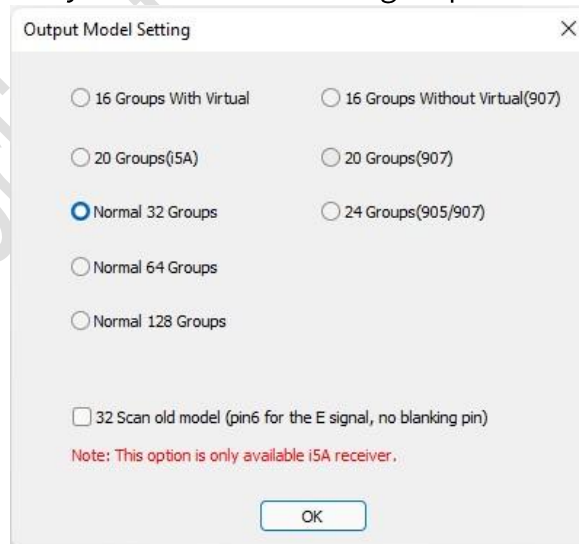

Fig 6.3.1.5 Data group

- Data group swap: Click the **Data Group Swap** button to open the **Data Group Swap** dialog box, which supports two modes of **Intelligent Mode**

and Swap Mode.

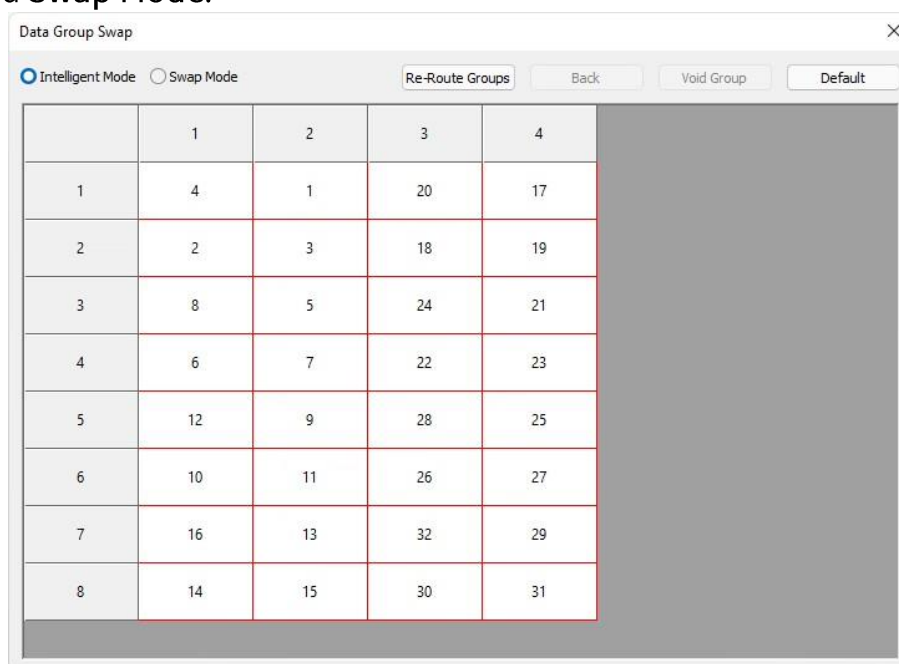

Fig 6.3.1.6 Data group swap

- Intelligent mode: Configure the data group location to make the cabinet display normally according to the screen display.

The intelligent mode is described as shown in Table 6.3.1-2.

Table 6.3.1-2 Intelligent mode

Feature	Description
Drawing area	Configure the sequence of data groups.
Re-route groups	Clear the sequence number of current data group and re-route the group.
Back	Click the button to return to the previous step.
Void group	Click the button to skip the sequence number of current data group.
Default	Reset the data group sequence number.

- Swap mode: Manually exchange the sequence number of data groups to achieve the normal display of the cabinets.

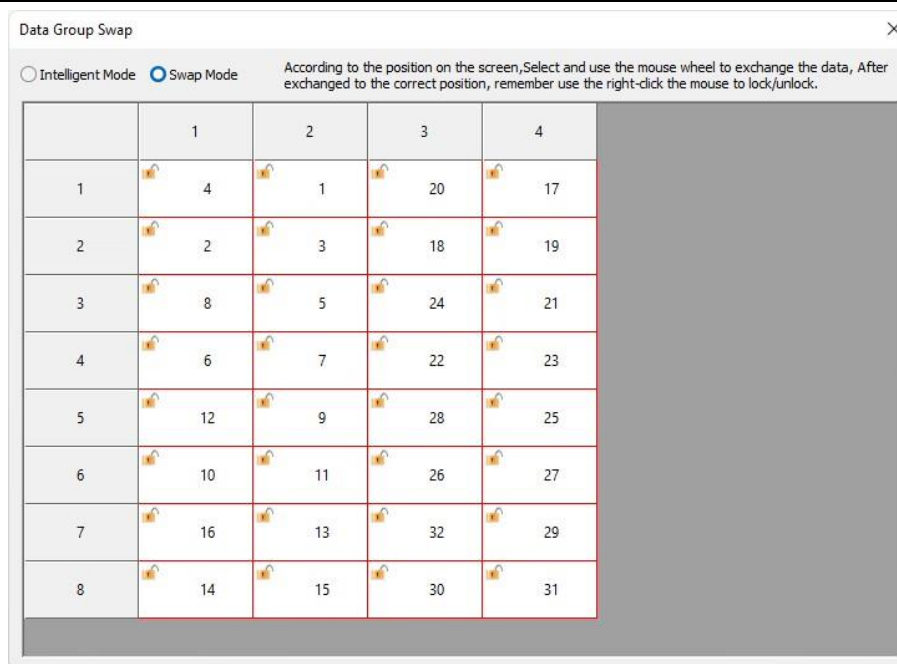



Fig 6.3.1.7 Swap mode settings

The swap mode actions are shown in Table 6.3.1-3.

Table 6.3.1-3 Actions of swap mode

Action	Description
Right mouse clicked	Lock or unlock the sequence number of data groups.
Left mouse clicked	Select the sequence number of data groups.
Mouse wheel	Changes the sequence number of the selected data group, and the locked data group is automatically skipped.

- Empty row/col: Display the number of empty rows and columns. Click  to open the **Empty Row/Col Settings** dialog box, which supports two modes of settings: **General Empty Row** and **Arbitrary Empty Row/Col**.
- General empty row: Only the empty row is supported.
- Starting row: Set the start for empty rows.
- Empty row count: Empty regular rows according to the number of rows you set.
- Arbitrary empty row/col: Support setting arbitrary empty rows and columns.

Quick Start

Step 1: Click the **+** button to open the **Add** dialog box and set the empty rows and columns according to the actual empty rows and columns position of the cabinets.

Step 2: Modify the width and height of the cabinets. As shown in Figure 6.3.1.8.

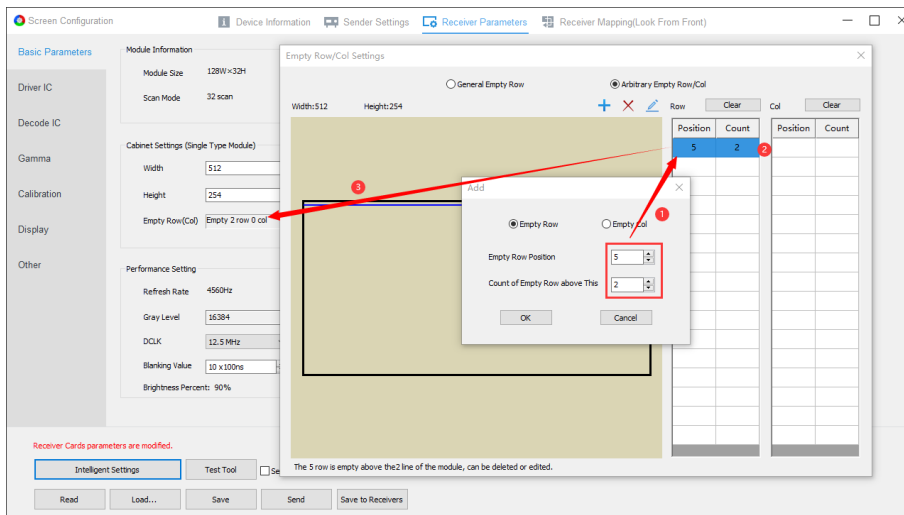

Fig 6.3.1.8 Empty row/col settings

The features of arbitrary empty row/col are shown in Table 6.3.1-4.

Table 6.3.1-4 Arbitrary empty row/col

Feature	Description
List	The list displays the empty rows and columns you set.
View area	Graphically display the empty rows and columns you set.
+	Click to add empty rows and columns.
×	Click to delete the selected empty rows and columns.
	Click to modify the position and number of the selected empty rows and columns.
Row clear	Clear the empty rows you set.
Col clear	Clear the empty columns you set.

- Intelligent module settings: Click the **Intelligent Module Settings** button to open the **Intelligent Module Setting** dialog box, which supports two modes: **Default Location** and **Customize Position**.

- Default location: Set module position according to the actual module size.

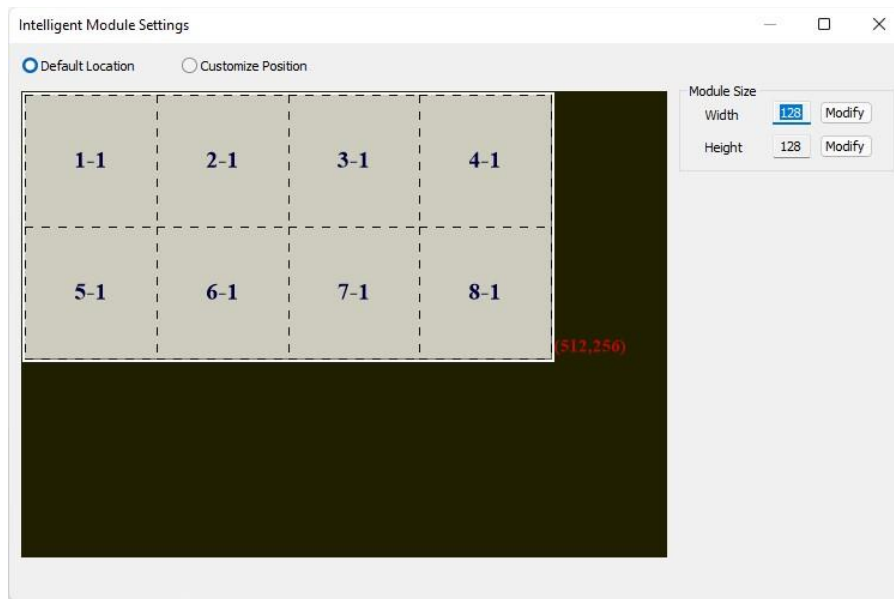

Fig 6.3.1.9 Default location

- ◆ Width: Click **Modify** to select the width of the module.
- ◆ Height: Click **Modify** to select the height of the module.
- Customize position: Set the position, size, and number of the intelligent module manually.

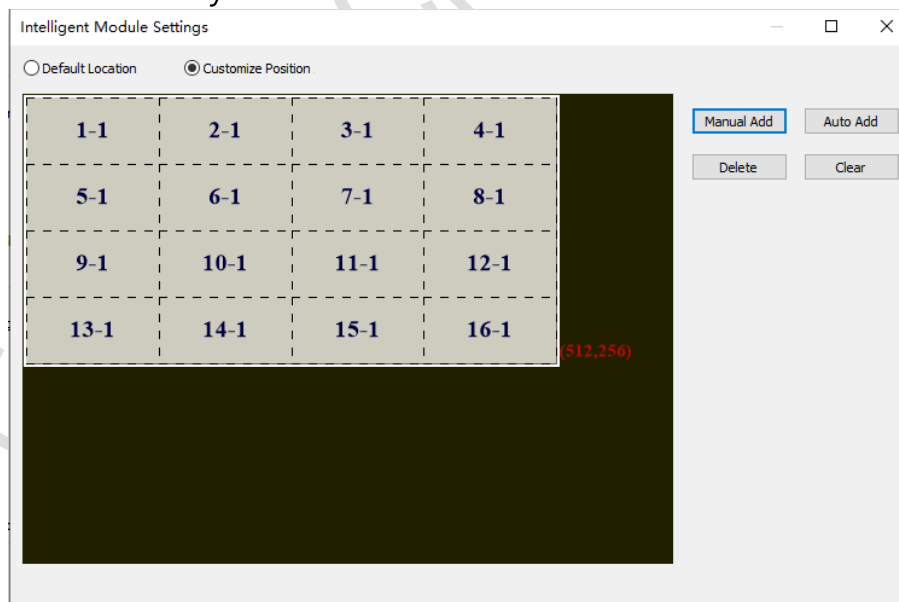

Fig 6.3.1.10 Customize position

- ◆ **Manual Add:** Click **Add** to open the **Add mod info** dialog box. Then, set the **Pin Number**, **Cascade Location**, **Module Position**, and **Module Size** for modules.

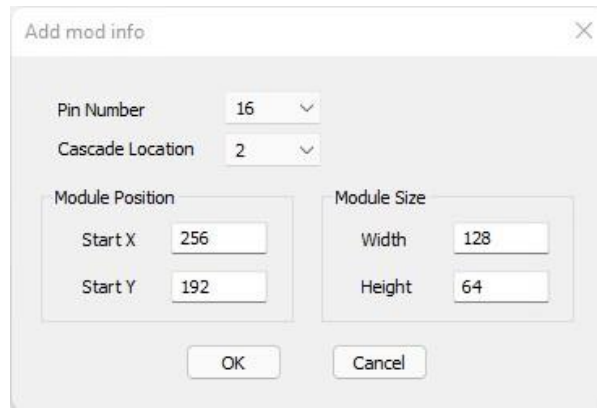

Fig 6.3.1.11 Add module information

- ◆ **Auto Add:** Copy the module settings from **Default Location**.
- ◆ **Delete:** Click to delete the selected intelligent module.
- ◆ **Clear:** Click to clear all intelligent modules.
- ◆ **Modify:** Select an intelligent module and modify its **Pin Number**, **Cascade Location**, **Module Position** and **Module Size** on the right side.

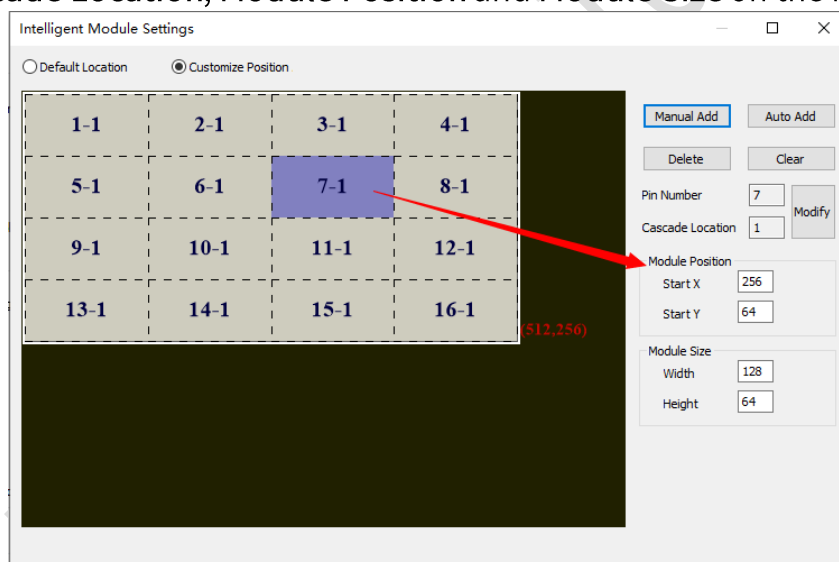

Fig 6.3.1.12 Modify

- **View area:** Display all the intelligent modules.
- **Cabinet information:** Click this button and open the corresponding dialog box to set the cabinet information and saving it to receiver card.

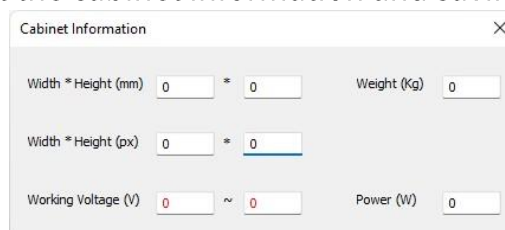

Fig 6.3.1.13 Cabinet information

Module Information (Multiple Type Module)

Switch module types on the right to check module information.

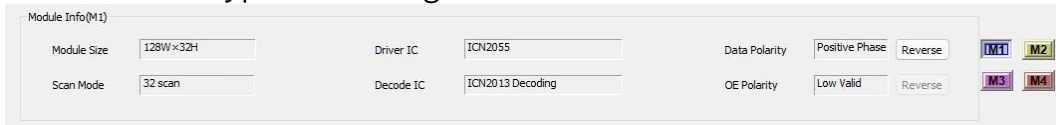

Fig 6.3.1.14 Module Information (Multiple Type Module)

Cabinet Settings (Multiple Type Module)

Configure basic parameters of cabinets.

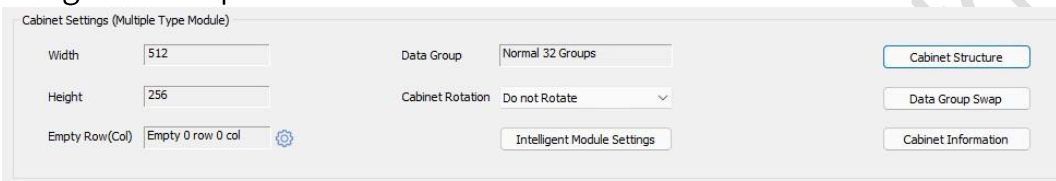

Fig 6.3.1.15 Cabinet Settings (Multiple Type Module)

Cabinet settings features are illustrated in Table 6.3.1-5.

Table 6.3.1-5 Cabinet settings

Feature	Description
Width	Show cabinet width.
Height	Show cabinet height.
Data group	Show cabinet data groups.
Cabinet rotation	Rotate cabinet displayed image.
Cabinet structure	Click this button to pop up the dialog box of Cabinet Structure .
Data group swap	Click this button to open dialog box of Data Group Swap .
Empty row(col)	Only Arbitrary Empty Row/Col mode is supported.
Intelligent module settings	Only Customize Position mode is supported.
Cabinet information	Set cabinet information and save it to receiver card.

- Cabinet structure: Add modules and set the layout and sequence number of data groups for the added modules to construct a complete

cabinet.

- Quick Start

Step 1: Click the **+** button and select the module type to add modules and construct the cabinet. As shown in Figure 6.3.1.16.

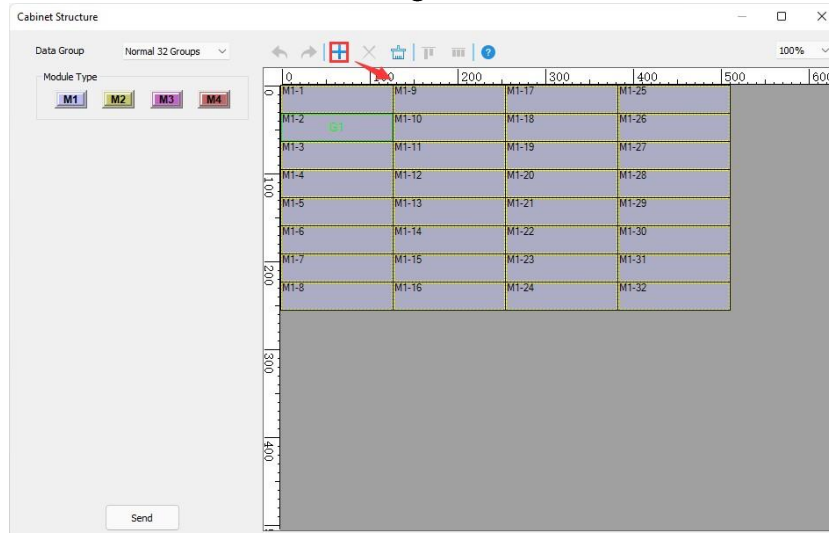

Fig 6.3.1.16 Construct cabinet

Step 2: Select the modules one by one to number the modules. When finished, click **Send** to complete the cabinet construction. As shown in Figure 6.3.1.17.

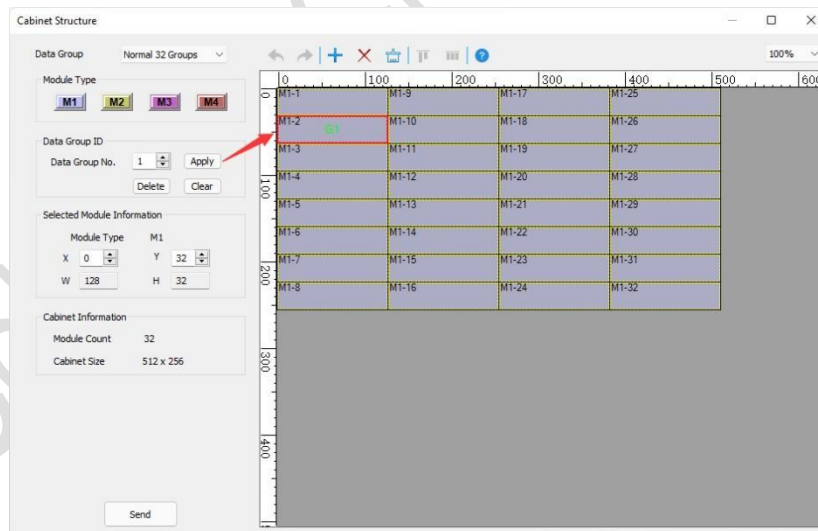

Fig 6.3.1.17 Data group numbering

- Left panel: Support configuring module types, data group numbering, modifying position and size, and viewing cabinet information.

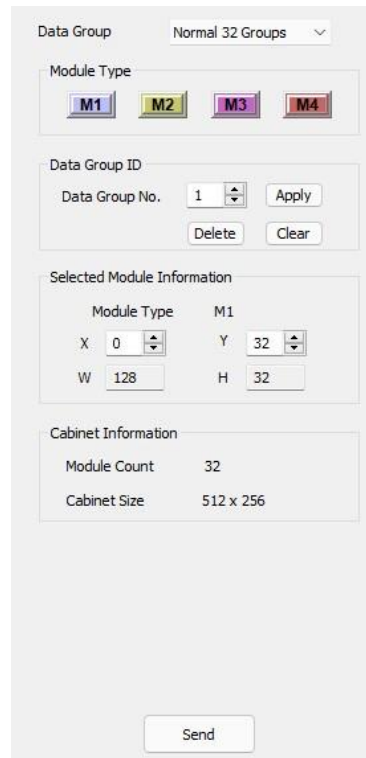

Fig 6.3.1.18 Left panel

- **Data group:** Modify the number of data groups from receiver card.
- **Module type:** Support adding, deleting, viewing, and editing.

The module type functions are described in Table 6.3.1-6.

Table 6.3.1-6 Module type function

Feature		Description
Right click module type	Remark	Rename the note for the Module Type .
	Import	Import a locally saved module type parameter file.
	Export	Export the module type parameter as a local file.
	View information	View the selected module type information.
	Delete	Delete the selected module type.
Add	Route pixels generate	Configure the module type information, enter Guide 8, and generate a new module type after the route is completed.
	Import from file	Import a locally saved module type parameter file to generate a new module type.

Double click module type	Enter Guide 8 Route interface.
--------------------------	--------------------------------

- Data Group ID: Number the data groups of the selected modules.

The data group numbering functions are described in Table 6.3.1-7.

Table 6.3.1-7 Data group numbering

Feature	Description
Data group No.	Set the sequence number of the data groups.
Apply	Apply the Data Group No. to the data groups of the selected modules.
Clear	Empty the data group sequence number of all modules.
Delete	Delete the data group sequence number of the selected modules.

- Selected Module Information: You can view module type, width and height, and position. Change the position of modules by modifying X, Y.
- Cabinet Information: Display the number of modules in the drawing area and cabinet size.
- Send: Send the cabinet information to the receiver card.
- Toolbar: Add, delete, and sort modules in the drawing area.

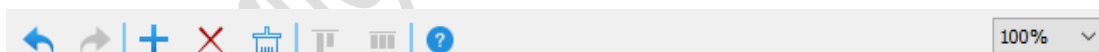









Fig 6.3.1.19 Cabinet structure toolbar

Toolbar function descriptions are shown in Table 6.3.1-8.

Table 6.3.1-8 Toolbar functions

Feature	Description
	Click to return to the previous step.
	Click undo the action in the previous step.
	Add a module to the drawing area.
	Delete the modules selected in the drawing area.
	Empty all modules in the drawing area.

	Select multiple modules to align the layout of modules.
	Select multiple modules to sort the layout of the modules.
	Open the Cabinet Structure help document.
Zoom	Zoom in/out by switching the drop-down box options or Ctrl + mouse wheel.







- Data group swap: Click the **Data Group Swap** button to open the **Data Group Swap** dialog box. Two modes are supported: **Intelligent Mode** and **Swap Mode**.
- Toolbar
- **Intelligent Mode**: Data group numbering based on cabinet display, where you can undo, restore, reset, and empty groups.
- **Swap Mode**: Exchange the sequence numbers of two data groups individually, which supports locking and unlocking functions.





Fig 6.3.1.20 Data group swap toolbar

The description of the data group swap toolbar functions is shown in Table 6.3.1-9.

Table 6.3.1-9 Toolbar

Feature		Description
		Turning on the screen test mode and the receiver card control area shows white.
	Switch modes	Restore normal mode before switching to other modes.
	Select data groups	In drawing area, left click to select the data group.
		Click to return to the previous step.
		Click to undo the previous step.
		Reset all data group numbers.
	Void group	Skip the current data group number.
	Data group	In drawing area, left click to number data groups.

No.		
		Lock or unlock all data groups. Locked data groups cannot be exchanged manually.
	Lock or unlock	In drawing area, right click to lock or unlock data groups.
	Swap data groups	In drawing area, swap the number of the selected data groups with mouse wheel.
Help		Open the help file.
Zoom		Zoom in/out by switching the drop-down box options or Ctrl + mouse wheel.

Module Information (Shaped Module)

Display basic information about the module, please refer to Single Type Module for more information.

Cabinet Settings (Shaped Module)

Configure the basic parameters of the cabinets, refer to Cabinet Settings (Multiple Type Module) for details.

Performance Setting

The display effect of the cabinets can be adjusted, which supports the configuration of Refresh Rate, Gray Mode, No Signal Action, Gray Level, GCLK, Enable Gradual, DCLK, Blanking Value, as well as view the Brightness Percent.

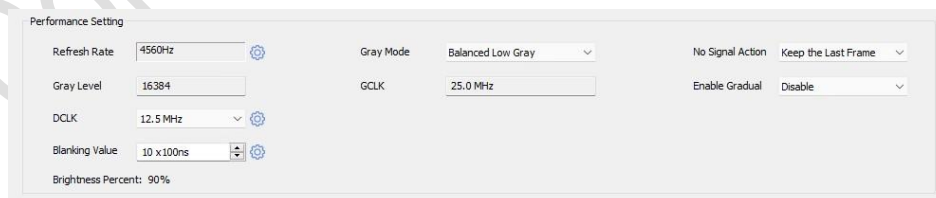



Fig 6.3.1.21 Performance setting

- Refresh rate: Display refresh rate, which is the number of times per second that the LED screen is able to draw a new image. The higher the refresh rate, the more stable the image.
- Gray mode: Select different modes to change the Gamma value of the

low-gray part in the gamma table, making the transition of the low-gray part more even.

- No signal action: Set the content displayed when the signal of receiver card is invalid.
- Gray level: The higher the grayscale level, the richer the color.
- GCLK: Display clock. The larger GCLK is, the higher the refresh rate, the grayscale, and the brightness percent.
- Enable gradual: When enabled, the screen becomes brighter gradually when the LED display is powered on to protect the LED beads.
- DCLK: Pixel clock. The higher the pixel clock, the higher the horizontal load capacity of the receiver card. Click  to adjust DCLK duty cycle.

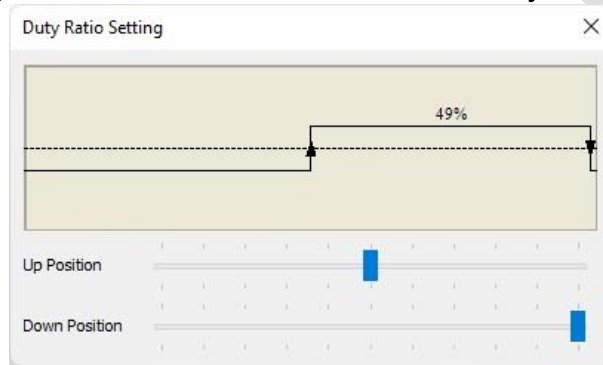



Fig 6.3.1.22 Duty ratio setting

- Blanking value: Solve the problem of dark LED beads and improve the display effect. Click  to adjust 4051 parameters for further optimization of the display effect.

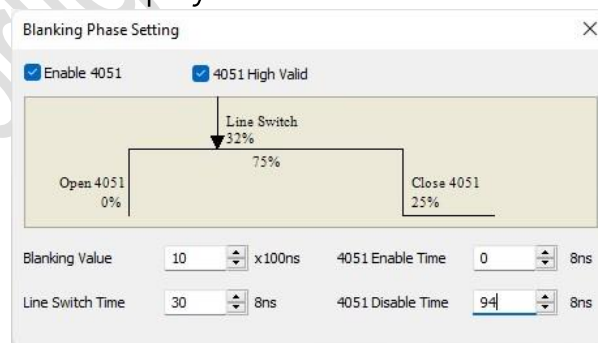

Fig 6.3.1.23 Blanking phase setting

- Brightness percent: The smaller blanking, lower refresh rate, and the higher gray level leads to the higher brightness percent.

6.3.2 Driver & Decode IC

Driver IC

The chip parameters can be adjusted to optimize the display effect of the LED cabinet, including chip param settings, extend settings, and advanced settings.

- Chip param settings: Adjust the current gains of red, green, and blue by dragging the slider.

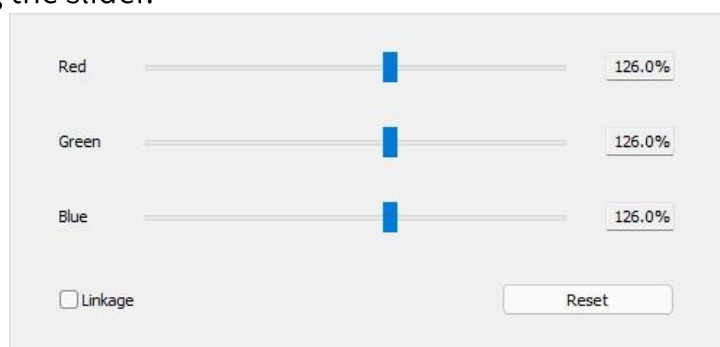

Fig 6.3.2.1 Current gains

The current gain function is described as shown in Table 6.3.2-1.

Table 6.3.2-1 Current gain

Feature	Description
Current adjustment	The higher the red, green, and blue current, the brighter the brightness.
Linkage	After ticking this checkbox, the red, green, and blue currents are synchronized for adjustment.
Reset	The red, green, and blue currents are reset to the default value.

- Extend settings: It can be used to adjust the advanced parameters of the driver IC to solve the problems of low gray color blocks, color cast, color spots, darkening of the first row, high-contrast coupling, and cross-board color difference, optimizing the display effect.
- Advanced settings: Register level parameters can be configured to optimize the display effect.

Decode IC

Blanking can be adjusted to eliminate the upper shadow of the display and improve the caterpillar failure caused by the short circuit of the beads.

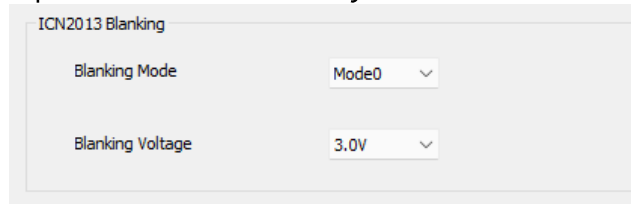

Fig 6.3.2.2 Decode IC

6.3.3 Gamma

The gamma values can be configured corresponding to different gray levels in the gamma table, making the image display more delicate.

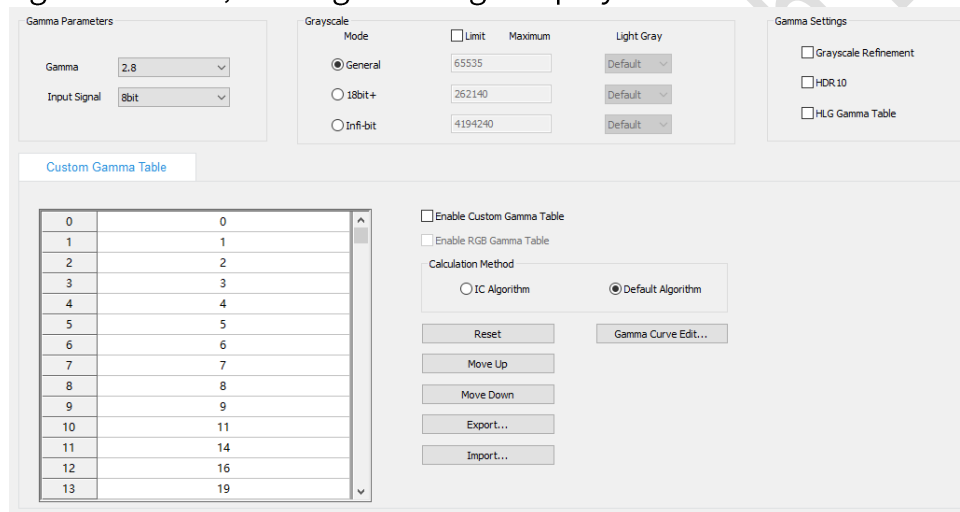

Fig 6.3.3.1 Gamma

Gamma parameters

- Gamma: Select the gamma coefficient to adjust the values in the gamma table.
- Input Signal: Adjust the color depth of the receiver card.

Grayscale

The grayscale supports three modes: **General**, **18bit+**, and **Infi-bit**. Switching modes will affect the custom Gamma table, HDR10, HLG gamma values.

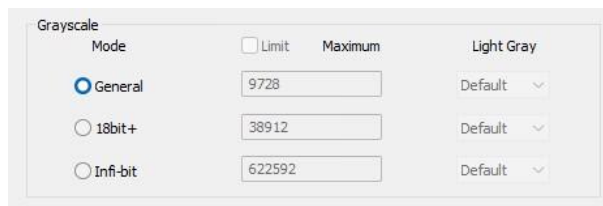

Fig 6.3.3.2 Grayscale

Grayscale features are described in Table 6.3.3-1.

Table 6.3.3-1 Grayscale

Feature	Description
Mode	Expand the gamma values in the gamma table. The general value is 16bit, and 18bit + and Infi-bit expand 2bit and 6bit respectively based on the general value.
Limit	Show the maximum gamma value for different modes.
Maximum	Tick to limit the maximum gamma value of the general mode.
Light gray	The gamma value is multiplied and only the Infi-bit mode is supported.

Advanced Gamma Settings

This feature consists of 3 settings: **Grayscale Refinement**, **HDR10**, and **HLG Gamma Table**. To access any given settings, select the checkbox to display the corresponding settings tab. For example, select the checkbox for **Grayscale Refinement** to display its tab in the interface.

Custom Gamma Table

Custom Gamma table supports setting gamma values for all grayscales and adjusts the display of cabinets at different grayscales.

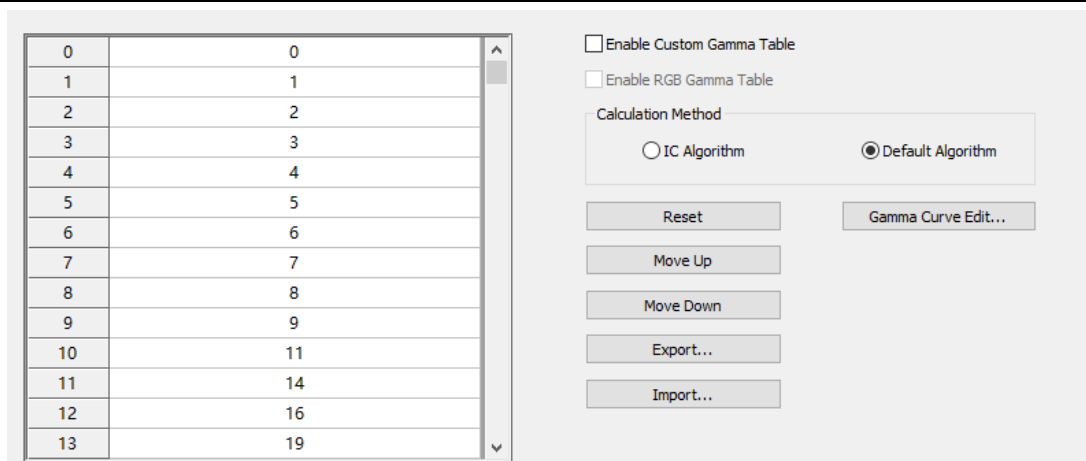

Fig 6.3.3.3 Custom Gamma table

Custom Gamma table features are shown in Table 6.3.3-2.

Table 6.3.3-2 Custom gamma table function

Feature	Description
Enable custom gamma table	Enable custom gamma tables to display corresponding grayscale with gamma values.
Enable RGB gamma table	The gamma value of red, green, and blue vector can be modified.
Calculation method	Support IC Algorithm and Default Algorithm . IC Algorithm is related to the driver IC and the Default Algorithm is based on the built-in gamma table.
Reset	Reset the custom Gamma table.
Move up	Select a Gamma value to move up one cell.
Move down	Select a gamma value to move down one cell.
Export	Export the custom gamma table parameters to a local file.
Import	Import a local parameter file to the custom gamma table.
Gamma curve edit	Edit the gamma table by adjusting the gamma curve.

- Gamma curve editing: After Gamma curve editing is completed, custom gamma table will be changed synchronously by clicking **Apply**.

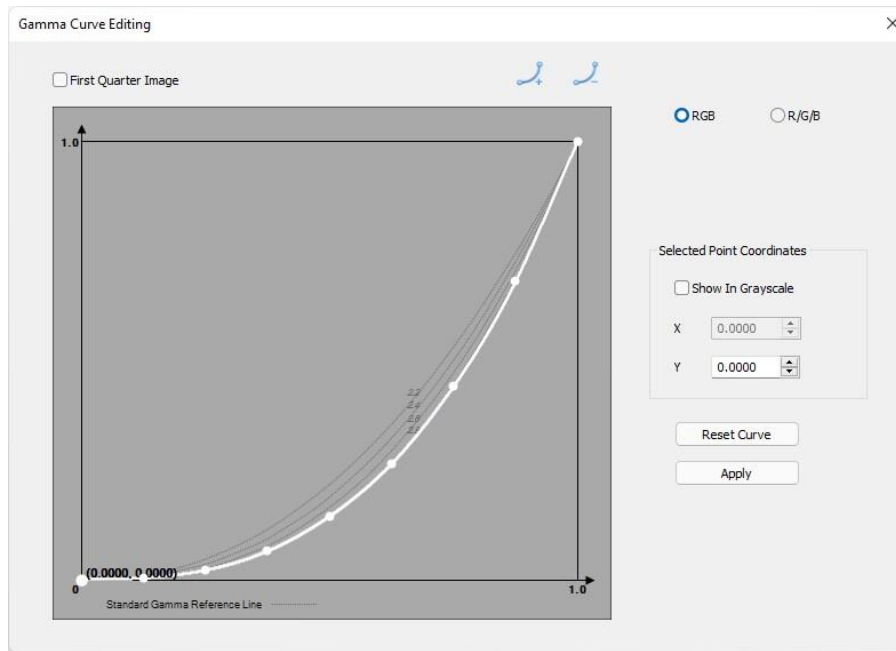



Fig 6.3.3.4 Gamma curve editing

The gamma curve editing function is described in Table 6.3.3-3.

Table 6.3.3-3 Gamma curve editing function

Feature	Description
First quarter image	The first 1/4 part of gamma curve is displayed in drawing area.
	Add route pixels on the gamma curve of the drawing area.
	Delete the route pixels on the gamma curve of the drawing area.
RGB	Modify the white gamma curve.
R/G/B	Modify red, green, and blue gamma curves.
Show in grayscale	Tick to convert the ordinate in the gamma curve to display with grayscale.
Reset curve	Reset to the gamma curve that specifies the gamma coefficient.
Apply	Click the button to apply the gamma curve to a custom gamma table.
Drawing area	Show the gamma curve, which can be adjusted by modifying the points.

Grayscale Refinement

Grayscale refinement mainly solves the problem of brighter low grayscale or darker high grayscale which are resulted from the circuit design, chip performance and other factors. Grayscale refinement is divided into White (Normal gray refinement) and RGBW (Infi-bit gray refinement).

- Quick Operations

Step 1: Set up the measurement environment to set the grayscale mode of the gamma table and enter the grayscale refinement tab. Enable grayscale refinement and click to reset the gray table and refined table.

Step 2: Click the **Measure** button to enter the grayscale refinement measurement window.

Step 3: Set the grayscale refinement measurement mode to match the grayscale mode of the gamma table. Click the **Measure** button, then the color meter begins to measure the data. As shown in Figure 6.3.3.5.

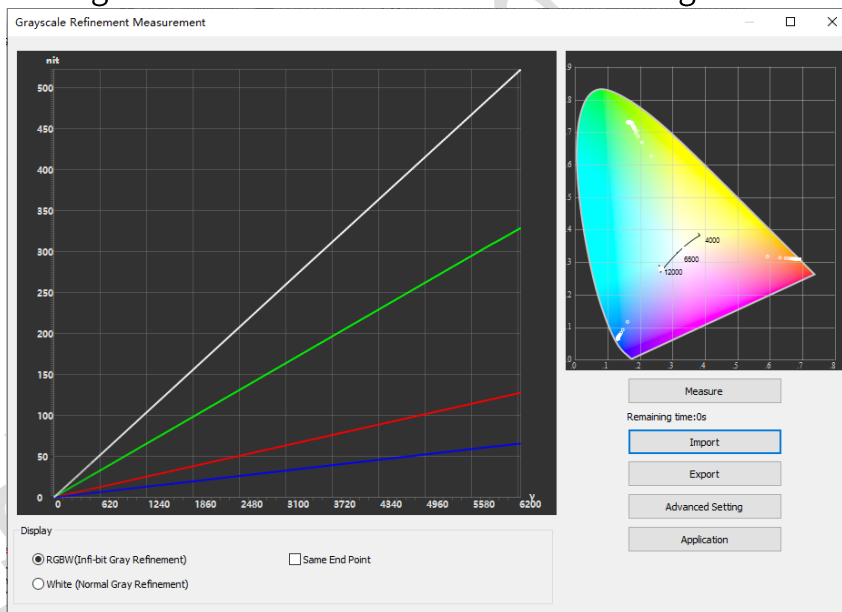

Fig 6.3.3.5 Grayscale refinement measurement

Step 4: When the measurement is completed, click the **Apply** button to update the gray table and refined table according to the measurement data.

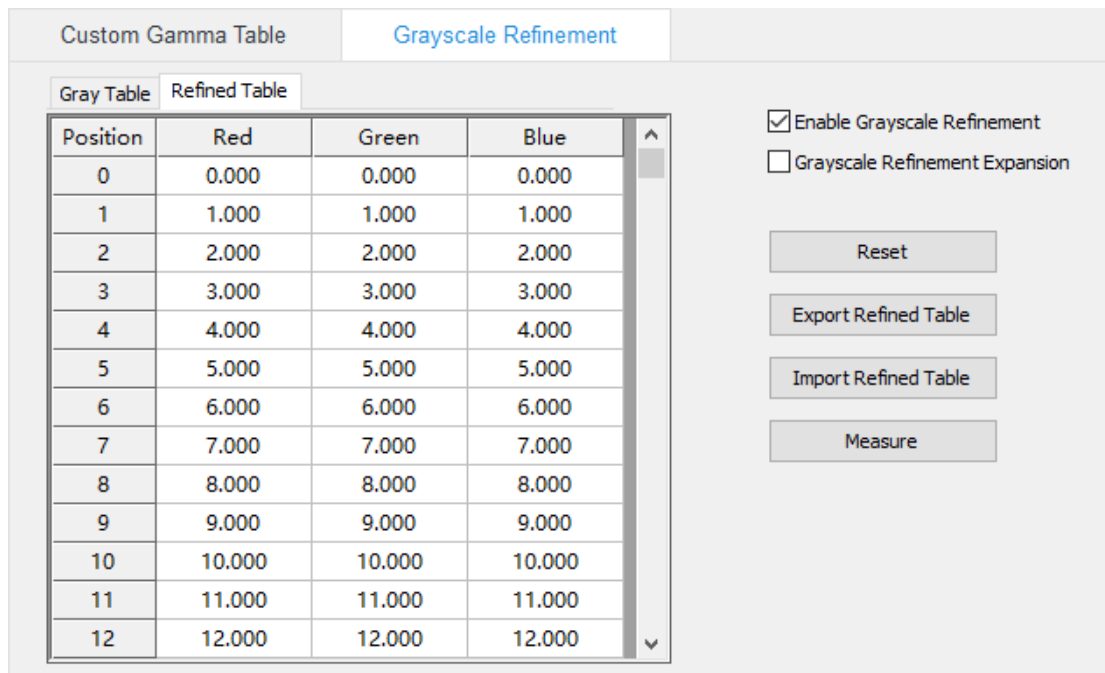

Fig 6.3.3.6 Interface after application

The grayscale refinement function is described in Table 6.3.3-4.

Table 6.3.3-4 Grayscale refinement function

Feature	Description
Refine Width	Support Grayscale Refinement Expansion , with available refine widths of 4096, 7168, and 13312.
Gray table	View and modify grayscale information.
Export gray table	Export the grayscale parameter to a local file.
Import gray table	Import the local parameter file to the gray table.
Refined table	View and modify refined table information.
Export refined table	Export the refined table parameters to a local file.
Import refined table	Import a local parameter file to the refined table.
Reset	Reset the gray table or refined table information.
Measure	Click the Measure button to open the grayscale refinement measurement window.

- Grayscale refinement measurement: The brightness at each grayscale of the red-green-blue-and-white display is measured by a color meter to

generate calibrated data according to the software algorithm. After application, LED display effect is optimized.

Grayscale refinement measurement function is shown in Table 6.3.3-5.

Table 6.3.3-5 Grayscale refinement measurement

Feature	Description
RGBW (Infi-bit Gray Refinement)	The gray mode for gamma table is Infi-bit .
White (Normal Gray Refinement)	The gray mode for gamma table is General or 18bit + .
Same End Point	When checked, all curve ends in the view area are at the same endpoint.
Measure	Click the Measure button to measure the curve in the current grayscale mode.
Import	Import a local parameter file into the view area.
Export	Export the view area measurement parameters to a local file.
Application	When applied, the gray table and refine table will be updated.
Advanced Settings	<p>Click to open the Advanced Settings dialog box.</p> <ol style="list-style-type: none"> 1. Select White Priority or Monochrome Priority as required. 2. Set Grayscale for measurement. 3. Set Refine Width for Grayscale Refinement Expansion. 4. Click OK to save the settings.
View area	Display the measurement curve.

HDR10

You can adjust HDR10 Gamma table information to optimize the HDR video display.

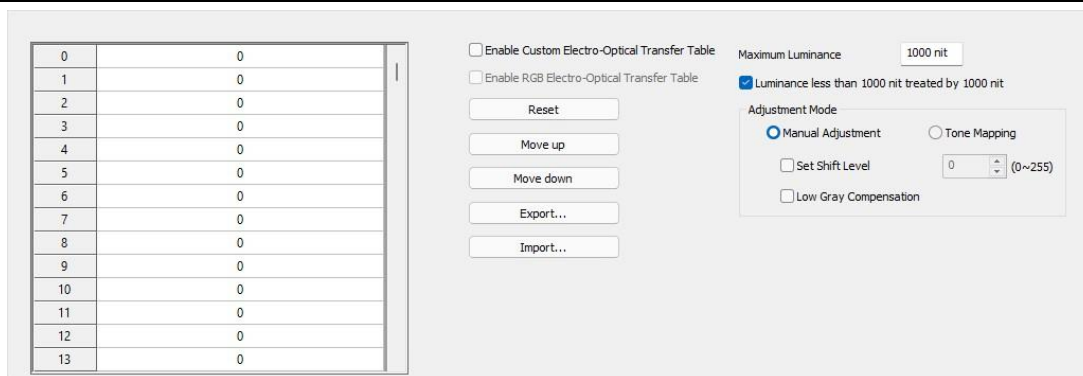

Fig 6.3.3.7 HDR10

HDR10 features are described in Table 6.3.3-6.

Table 6.3.3-6 HDR10 function

Feature	Description
Enable custom electro-optical transfer table	Enable custom electro-optical transfer table to display the corresponding grayscale with Gamma values.
Enable RGB electro-optical transfer table	The Gamma value of red, green, and blue vectors can be modified.
Reset	Reset the HDR10 Gamma table.
Move up	Select a Gamma value to move up one cell.
Move down	Select a Gamma value to move down one cell.
Export	Export the HDR10 Gamma table parameter as a local file.
Import	Import the local parameter file to the HDR10 Gamma table.
Maximum luminance	Adjust the maximum brightness of the LED screen.
Adjustment mode	Adjust the values in the Gamma table to support both manual adjustment and tone mapping modes.

HLG Gamma Table

You can adjust HLG Gamma table information to optimize HLG video display.

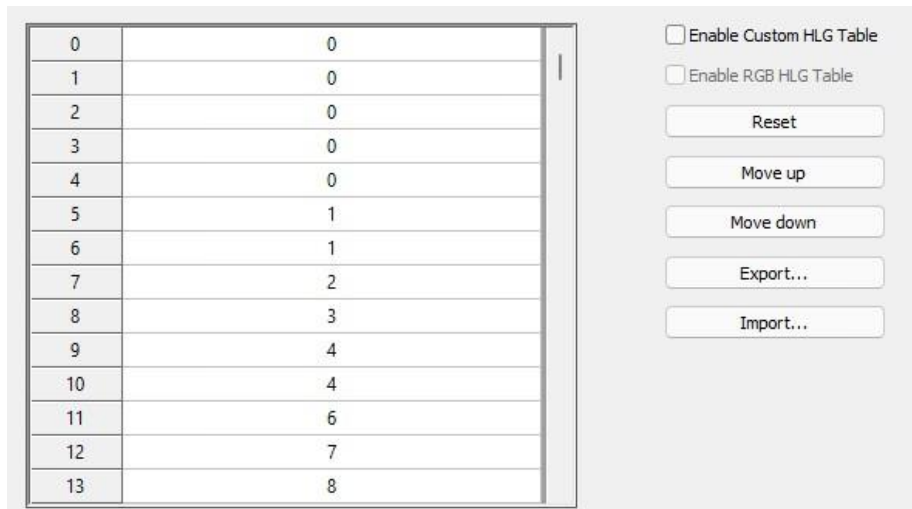

0	0
1	0
2	0
3	0
4	0
5	1
6	1
7	2
8	3
9	4
10	4
11	6
12	7
13	8

Fig 6.3.3.8 HLG Gamma table

HLG gamma table features are described in Table 6.3.3-7.

Table 6.3.3-7 HLG Gamma table

Feature	Description
Enable custom HLG table	Enable the custom HLG table to display the corresponding grayscale at gamma values.
Enable RGB HLG table	The gamma value of red, green, and blue vectors can be modified.
Reset	Reset the HLG gamma table.
Move up	Select a gamma value to move up one cell.
Move down	Select a gamma value to move down one cell.
Export	Export the HLG gamma table parameters to a local file.
Import	Import the local parameter file to the HLG gamma table.

6.3.4 Calibration

Calibration Mode

Switch the calibration status of the cabinets.

Calibration Source

Select the source of the cabinet calibration coefficient.

Advanced Deseam

Turn on or turn off advanced deseam.

Double Calibration

Set the grayscale interval where double calibration (low grayscale and high grayscale) coefficients take effect.

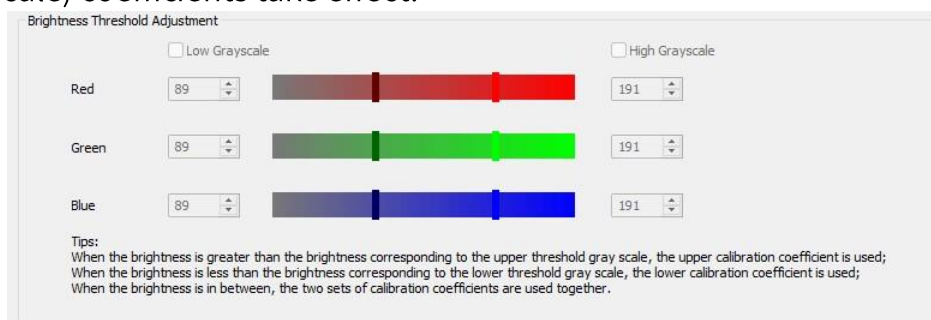

Fig 6.3.4.1 Double calibration

- Low grayscale: Turn on or off low grayscale calibration.
- High grayscale: Turn on or off high grayscale calibration.
- Brightness threshold adjustment: Adjust the low grayscale and high grayscale thresholds by sliders or input boxes.

Low Gray Calibration

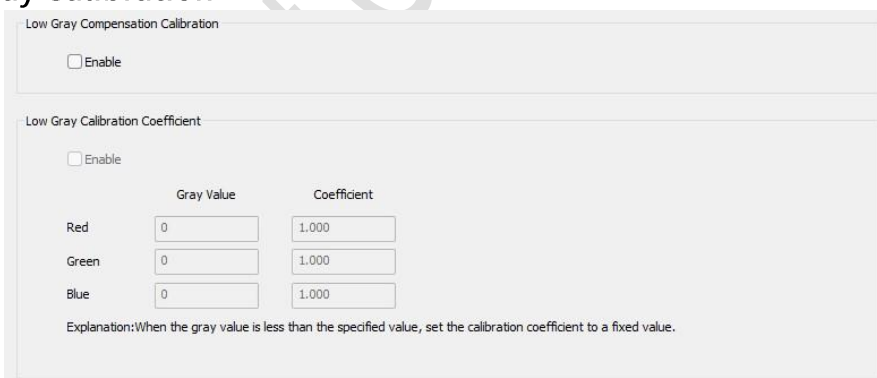

Fig 6.3.4.2 Low gray calibration

- Low gray compensation calibration: Enable or disable the **Low Gray Compensation Calibration** function of the receiver card. For the coefficient sending, please refer to Chapter 8.4.2.
- Low gray calibration coefficient: When the screen shows a grayscale value less than the grayscale value you set, please use the given correction coefficient.

- **Enable:** Turn on or off the **Low Gray Calibration Coefficient** function.
- **Gray value:** Set the interval where the low gray calibration coefficient of red, green, and blue takes effect.
- **Coefficient:** Set the coefficient for the low gray calibration coefficient.

Thermal Dynamic Calibration

This feature addresses the problem of reduced screen calibration effect resulting from changes in screen temperature.

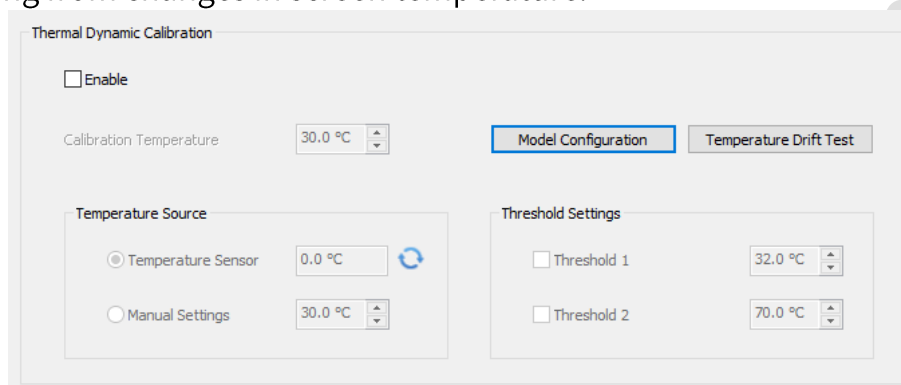

Fig 6.3.4.3 Thermal dynamic calibration

- **Enable:** Turn on or off the **Thermal Dynamic Calibration** function.
- **Calibration Temperature:** Set the temperature for screen calibration.
- **Temperature Source:** Get screen temperature. You can apply different models based on detected temperature changes to adjust the calibration effect.
- **Temperature Sensor:** Get data from an external temperature sensor connected to the cabinet.
- **Manual Settings:** Enter the screen temperature value manually.
- **Threshold Settings:** Set the temperature range for model 1 and model 2 to take effect.

Notes:

0°C ~ calibration temperature: No calibration model should be applied.

Calibration temperature ~ threshold 1: Model 1 should be applied.

Threshold 1 ~ threshold 2: Both model 1 and model 2 should be applied.

Threshold 2 ~ 100°C: Model 2 should be applied.

-
- **Model Configuration:** Click to open the **Model Configuration** dialog box, as shown in the figure below.

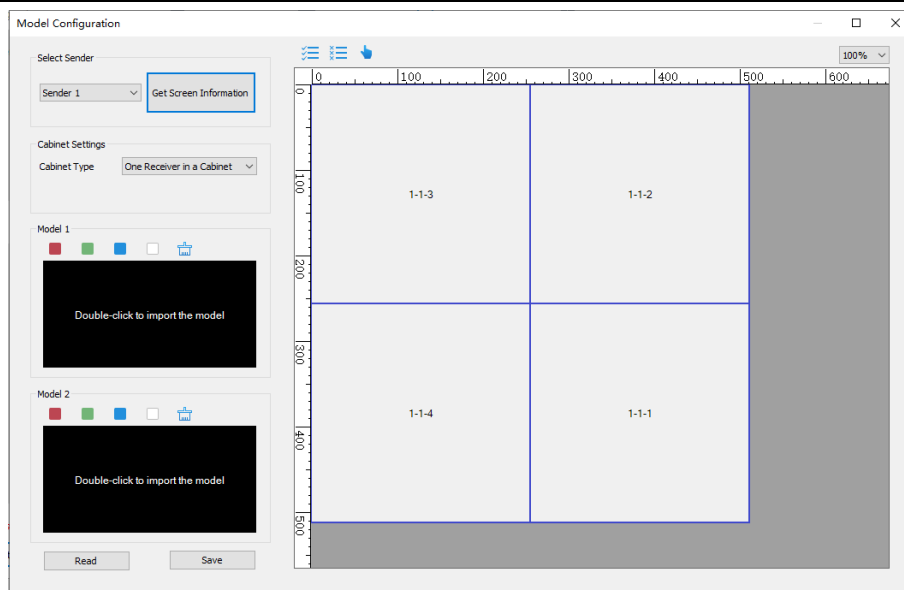





Fig 6.3.4.4 Model configuration

- **Select Sender:** Select a sender from the drop-down options under **Select Sender**. Click **Get Screen Information** to obtain a real-time mapping diagram of the receiver cards connected to the selected sender. The mapping will be displayed in drawing area on the right side.
- **Cabinet Settings:** Configure **Cabinet Type**, with 4 available options - **One Receiver in a Cabinet**, **Two Receivers in a Cabinet**, **Four Receivers in a Cabinet**, and **Six Receivers in a Cabinet**.
- **Model 1/Model 2:** Double-click to import a local brightness/chrome model. Once imported, the model is saved to your user profile and can be previewed immediately. To view the model's effects under different colors, switch between the icons of **Red**, **Green**, **Blue**, and **White**. Click  to delete the imported model.
- **Read:** Read back the model of the selected receiver card.
- **Save:** Save the model from the current interface to the selected receiver card.
- **Toolbar**
 - : Select all receiver cards.
 - : Unselect all receiver cards.
 - : Highlight the selected receiver card.
- **Temperature Drift Test:** Collect color gamut information of the display screen under different temperatures.

- **Measure Mode:** Support 2 modes, namely, **Measure Original Data** and **Effect Verification**.

📖 Prerequisites for Measurement

1. Disable color gamut adjustment and dynamic color temperature adjustment using Colorlight' s ColorAdept. Adjust the color temperature to 6500K.
2. Enable **Infi-Bit**, **Grayscale Refinement**, and **Calibration**.

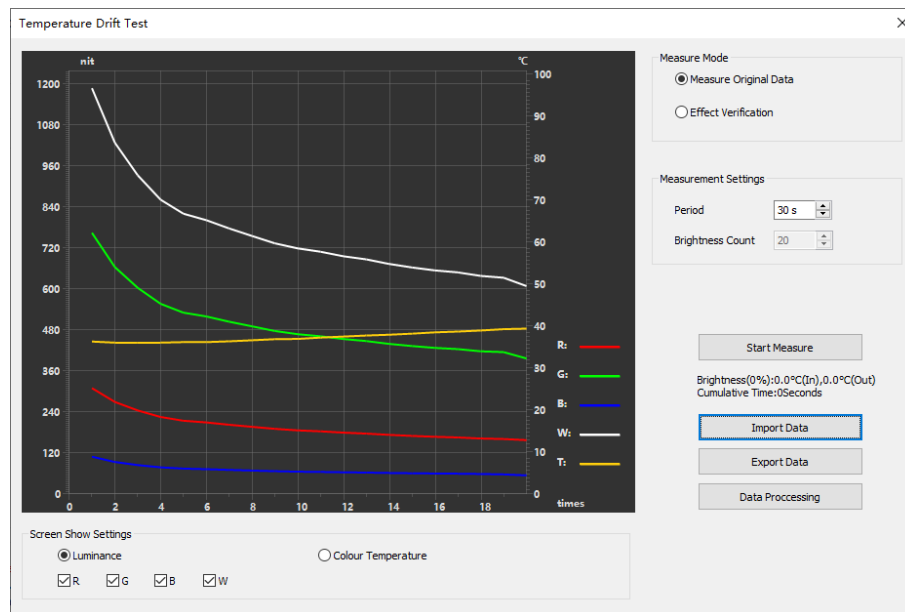

Fig 6.3.4.5 Temperature drift test

- **Drawing Area**

Left vertical axis: Indicates **Luminance** (nits) or **Colour Temperature** (K). The step per grid is dynamically displayed based on the cabinet' s measured maximum and minimum values.

Right vertical axis: Indicates temperature (°C) ranging from 0°C to 100°C. Each grid represents 10°C.

Horizontal axis: Indicates measurement time (min) calculated based on measurement period and times.

Curves: Display the brightness curves for red, green, blue, and white in corresponding colors. The temperature curve (T) is displayed in yellow.

Coordinate grid: 10×10 by default. You can drag your mouse to adjust the coordinate accuracy.

- **Display**

- ◆ **Measure Original Data**

Luminance: The coordinate system displays the relation curve between temperature and **Luminance**, supporting separate display of red, green, blue, and white curves.

Colour Temperature: The coordinate system displays the relation curve between temperature and **Colour Temperature**.

◆ **Effect Verification**

Luminance: The coordinate system displays the relation curve between temperature and **Luminance**, supporting separate display of white only.

Colour Temperature: The coordinate system displays the relation curve between temperature and **Colour Temperature**.

■ **Measurement Settings**

◆ **Measure Original Data**

Period: Set the time interval for a single measurement.

Brightness Count: The default value is 20 and cannot be adjusted. This setting divides the sender's brightness range into 20 levels.

◆ **Effect Verification**

Period: Set the time interval for a single measurement.

Count: Set the total number of measurements.

■ **Start Measure:** Click to start measurement according to **Measurement Settings**. Click again to stop measurement.

◆ **Measure Original Data**

The brightness and temperature of the screen, as well as accumulative time for measurement are shown under the **Start Measure** button.

◆ **Effect Verification**

The remaining time for measurement is shown under the **Start Measure** button.

■ **Import Data:** Import the measurement data from a local file.

■ **Export Data:** Export the measurement data to a local file.

■ **Data Processing:** The software fits tristimulus values across 0~100°C in 1°C increments for different colors based on measurement data. The

data will be exported and saved as a local file.

Calibration Coefficient Rotation

After ticking the checkbox, the coefficient automatically changes following the cabinet rotation.

Low Gray Deseam



Specify Seam Coefficient in Low Gray

Enable

	Gray Value	Coefficient	
Red	0	1.000	(0.504~1.497)
Green	0	1.000	(0.504~1.497)
Blue	0	1.000	(0.504~1.497)

Explanation: When the gray value is less than the specified value, set the seam coefficient to a fixed value.

Fig 6.3.4.6 Specify seam coefficient in low gray

- Specify seam coefficient in low gray: When the gray value displayed on the screen is less than the gray value set by the software, the coefficient will be used.
- Enable: Enable or disable the function of Specify Seam Coefficient in Low Gray.
- Gray value: Set the interval in which the Specify Seam Coefficient in Low Gray takes effect for red, green, and blue.
- Coefficient: Set the seam coefficient to be used for Specify Seam Coefficient in Low Gray.

Multi-Layer Deseam

Set the gray scale interval in which the Multi-layer Deseam Coefficient takes effect.



Threshold Adjustment

Enable

	Gray	
First Coefficient	229	(0-255)
Second Coefficient	191	(0-255)
Third Coefficient	127	(0-255)
Fourth Coefficient	89	(0-255)

Fig 6.3.4.7 Multi-Layer deseam

6.3.5 Display

White Balance

You can modify the proportion of red, green, and blue colors to optimize the white effect of the display screen.



Fig 6.3.5.1 White balance

Color Exchange

Color exchange is used to adjust the order of the red, green, and blue signal outputs from the video source to the physical pins of the receiver card.

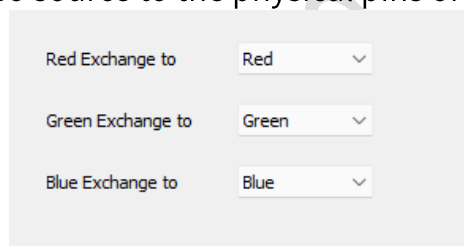

Fig 6.3.5.2 Color exchange

Photo Optimization

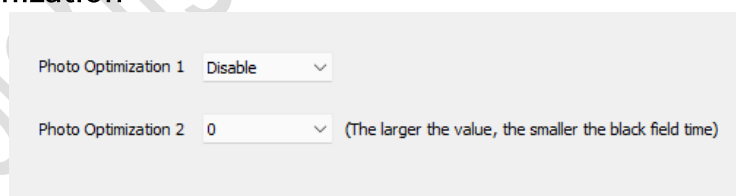

Fig 6.3.5.3 Photo optimization

- Optimize photos taken with the camera.
- Photo Optimization 1: Enable or disable the photo optimization function.
- Photo Optimization 2: Optimize the black field time during LED screen swap scan.

6.3.6 Other

Phase Adjustment

By adjusting SCLK, LAT, swap scan signal, R, G and B phase parameters, the signal frequency is changed to avoid abnormal screen display caused by the same frequency of the signal output from the receiver card.

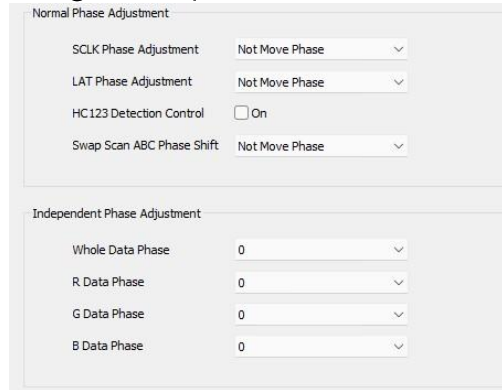

Fig 6.3.6.1 Phase adjustment

Scan Order

Scan order can be applied to change the scanning mode of the row selection signal of screen output, which supports progressive scanning and interlaced scanning and needs to be supported by the receiver card program.

Data Remapping

After importing the file, select **Enable Custom Data Remapping Table** for the remapping of the imported data.

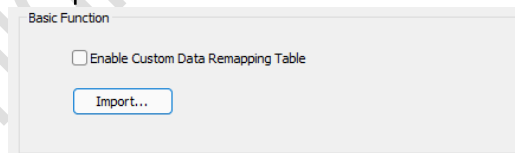

Fig 6.3.6.2 Data Remapping

EMC

By adjusting the system clock phase shift and SCLK phase shift, EMC strengthens the immunity of hardware devices to electronic magnetic fields.

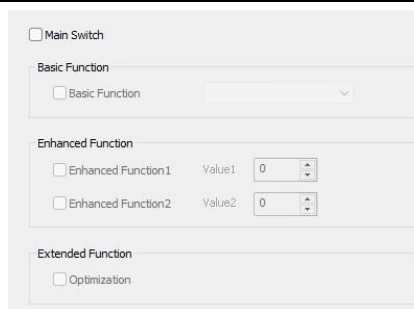

Fig 6.3.6.3 EMC

Independent Setting

Set the on/off state of the green indicator on the receiver card.

6.3.7 Intelligent Settings

Configure the parameters of the receiver card to light up the modules with intelligent settings.

Prerequisite: The **Intelligent Settings** function needs to be supported by the program of receiver card to display the intelligent settings effect.

- This software supports 3 types of module parameter configurations: single type, multiple type, and shaped modules.
- Single-type module: Within a single module, it supports only one data group and one regular routing.
- Multi-type module: Within a single module, it supports multiple data groups and multiple regular routings.
- Shaped Module: Within a single module, it supports multiple data groups and multiple irregular routings.

Single Type Module

➤ Guide 1

Click the intelligent settings button to enter Guide 1, and select **Single Type Module** as the cabinet type.

➤ Guide 2

In Guide 2, you can set the cabinet information, module size, and module information for a single type module.

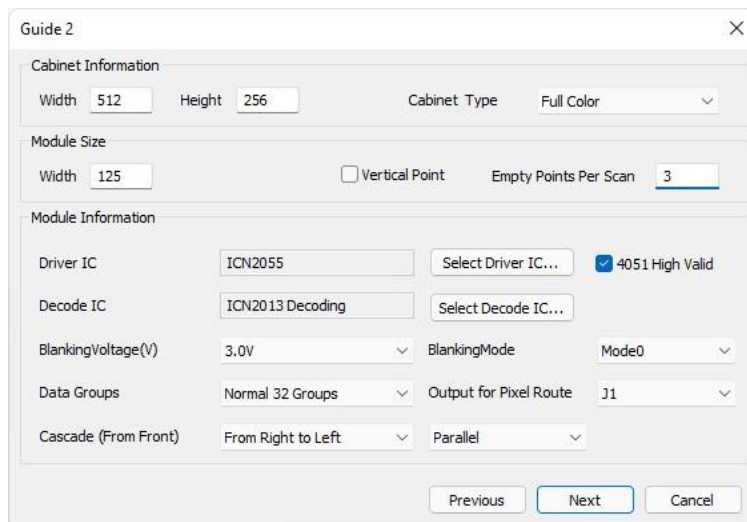

Fig 6.3.7.1 Guide 2 for single type module

The Single Type Module Guide 2 functions are described in Table 6.3.7-1.

Table 6.3.7-1 Guide 2 for single type module

Feature	Description
Width	Set the width to match the actual cabinet width.
Height	Set the height to match the actual cabinet height.
Cabinet type	Support 3 cabinet types: full color, monochrome, and double color.
Width	Set columns of a single data group in the module.
Vertical point	This function is enabled when the module routes vertically.
Empty points per scan	Set the number of empty points per scan which can be up to 128. After setting the empty points, Guide 8 will show the empty point configuration and other functions.
Driver IC	Select the corresponding driver IC according to module.
Decode IC	Select the corresponding decode IC according to module.
Data groups	Set the number of data groups to be output from the receiver card.
Output for pixel route	Select the physical J-port position of the receiver card shown in Intelligent Setting Effect .
Cascade	When the cabinet position is incorrect, use this function to make the screen display normally.
Data type	Set the data type of the module: parallel, serial (R16G16B16), and

	serial (R1G1B1).
Previous	Click the button to return to the previous Guide.
Next	Click the button to go to the next Guide.
Cancel	Click the button to cancel the intelligent settings.

➤ Guide 3

Guide 3 is applied to set the data polarity of modules. Switch state 1 and 2 to select the corresponding option according to the display state of the module.

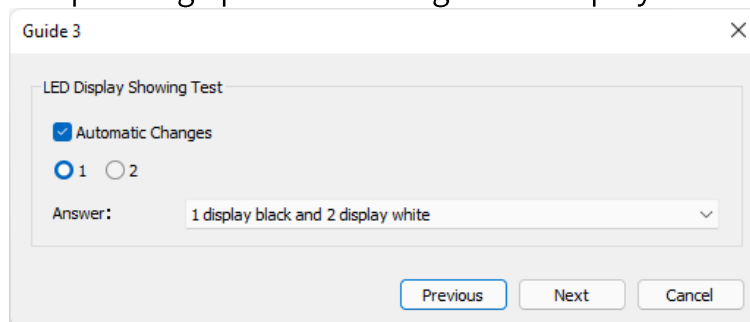

Fig 6.3.7.2 Guide 3 for single type module

➤ Guide 4

Guide 4 can be used to set the OE polarity of modules. Switch state 1 and 2 to select the corresponding option according to the display state of the module. Guide 4 will be displayed only when **Normal Type** of driver IC is selected.

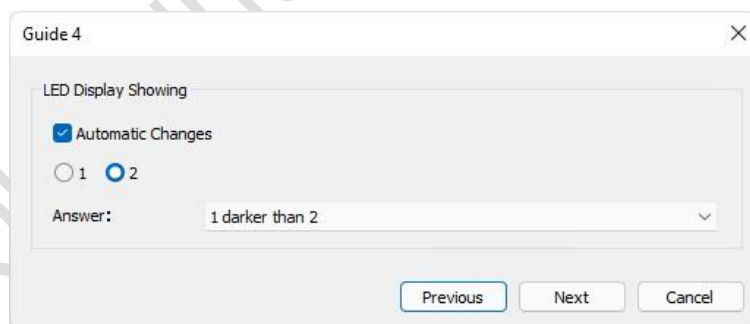

Fig 6.3.7.3 Guide 4 for single type module

➤ Guide 5

Guide 5 is designed to set the signal output order of red, green, and blue from the video source to the physical pins of the receiver card. Switch state 1, 2, 3, 4 and select the corresponding option according to the module display status.

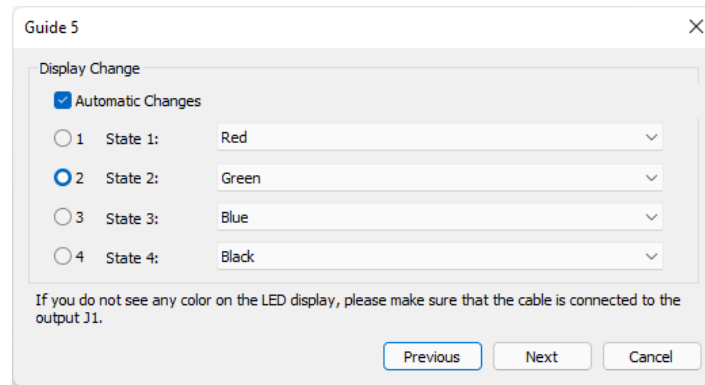

Fig 6.3.7.4 Guide 5 for single type module

➤ Guide 6

Set the height of individual data groups according to the number of rows displayed on the module.

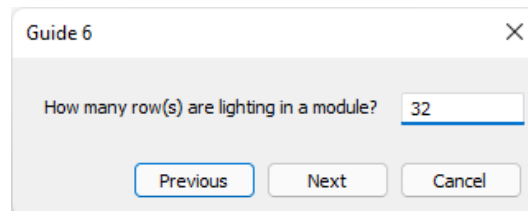

Fig 6.3.7.5 Guide 6 for single type module

➤ Guide 7

Guide 7 can be used to set the number of rows displayed for each scan of a single data group according to the number of rows on the module.

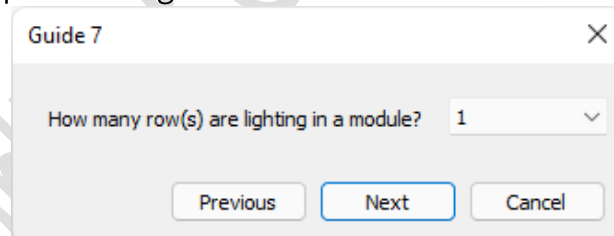

Fig 6.3.7.6 Guide 7 for single type module

➤ Guide 8

Guide 8 is designed to set the trace information and routing for a single type module. The window is divided into a function bar and a drawing area.

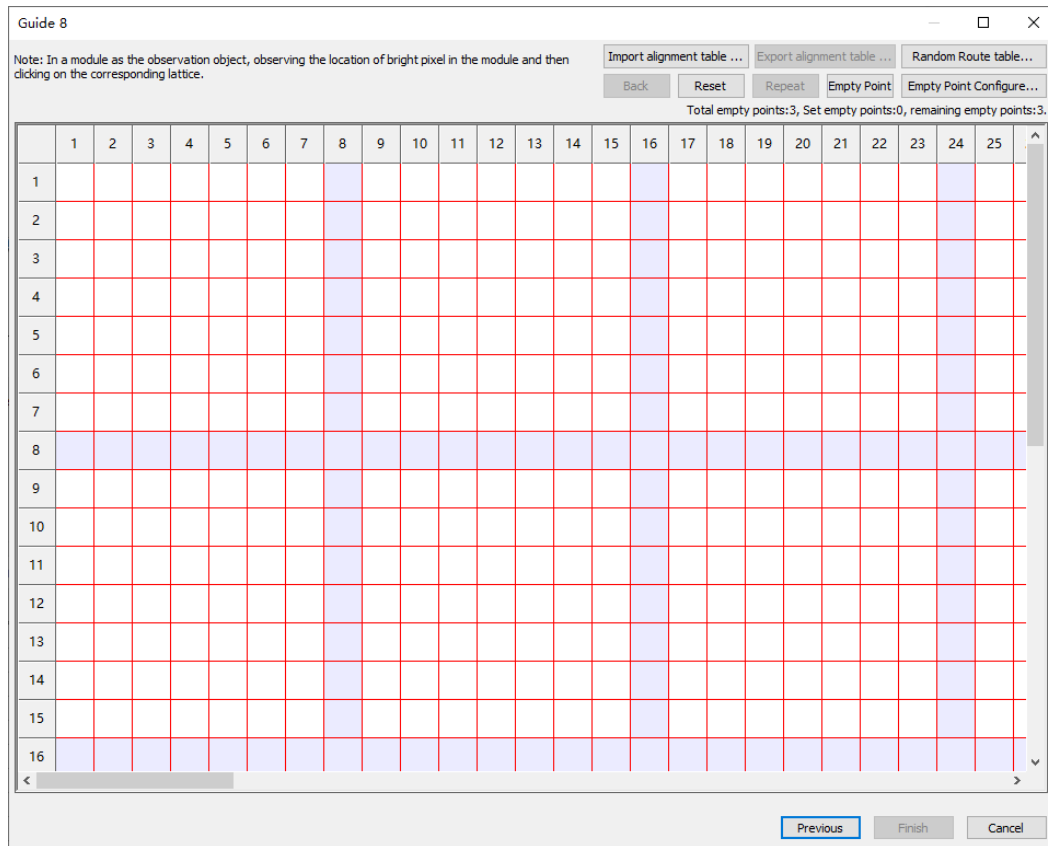

Fig 6.3.7.7 Guide 8 for single type module

- Function Bar

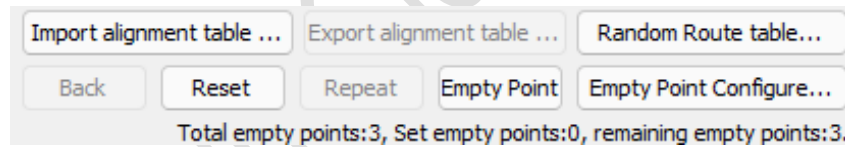

Fig 6.3.7.8 Function bar

The function bar features are described as shown in Table 6.3.7-2.

Table 6.3.7-2 Function bar

Feature	Description
Import alignment table	Click the button to import the local alignment table.
Export alignment table	After finishing the trace, click the button to export the alignment table to a local file.
Random route table	Click the button to open the Manual Paint Route Table dialog box and trace randomly.
Back	Return to the previous step of trace.
Reset	Reset the trace information in the drawing area.

Repeat	Support repetition of the current trace.
Empty point	Click the button to add an empty point at the current position.
Empty point configuration	Click the button to open the Empty Point Configuration dialog box.
Previous	Click the button to return to the previous Guide.
Finish	Click on the button to complete the intelligent settings and synchronize the information in basic parameter interface.
Cancel	Click the button to cancel the intelligent settings.

- Manual paint route table: This mode is used when there is a difference in trace points between scans in the route table.

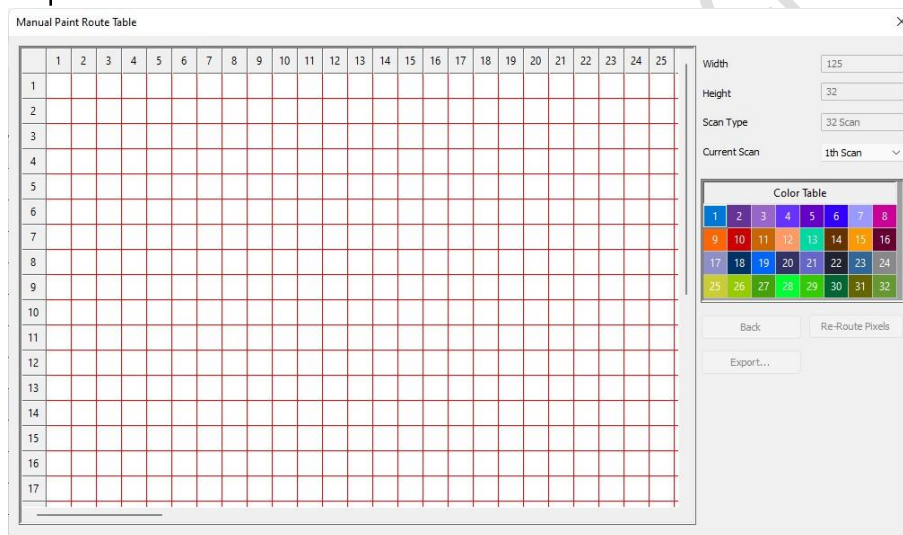

Fig 6.3.7.9 Manual paint route table

The manual paint function is described as shown in Table 6.3.7-3.

Table 6.3.7-3 Manual paint function

Feature	Description
Width	Same as the number of module columns set in Guide 2.
Height	Same as the number of module rows set in Guide 6.
Scan type	Same as the result of dividing the number of rows in Guide 6 by the number of rows in Guide 7.
Current scan	Select the number of scans for trace.
Color table	Select the number of scans for trace.

Back	Return to the previous step.
Re-route pixels	Reset the trace of the drawing area.
Export	When trace is finished, click the button to export the route table to a local file.
Drawing area	Trace pixels for each scan which will be automatically overwritten to the drawing area of Guide 8 when finished.

- Empty point configure: Configure the position of the empty point for the first scan and repeat the empty point for the other scans.

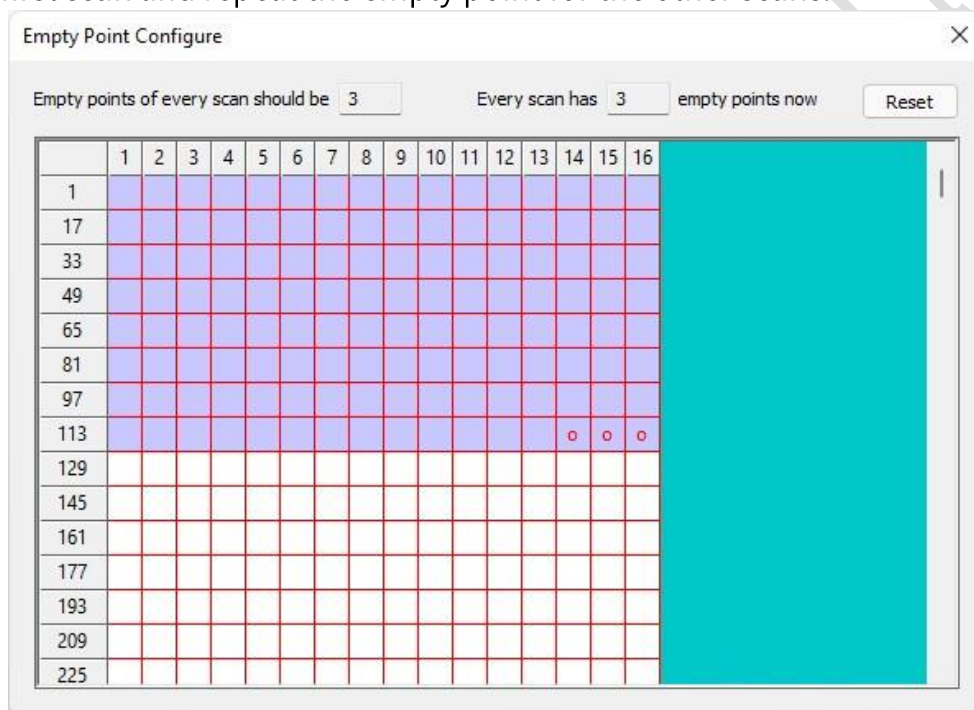



Fig 6.3.7.10 Empty point configure

- Reset: Click the button to reset the empty point.
- Empty point drawing area: Click  to cancel the empty point and click  to set the empty point.
- Drawing area: It displays the trace information for the module. You can trace points following the “blinking dot” displayed on the module.
- Trace point: When the points are not traced, click in the drawing area to trace points manually.
- Trace scan: After completing the first scan, click on the drawing area to trace the scans.

Multiple Type Module

➤ Guide 1

Click the Intelligent Settings button to enter Guide 1 and select **Multiple Type Module** as the cabinet type.

➤ Guide 2

Set the driver/decode IC and module information for multiple type module.

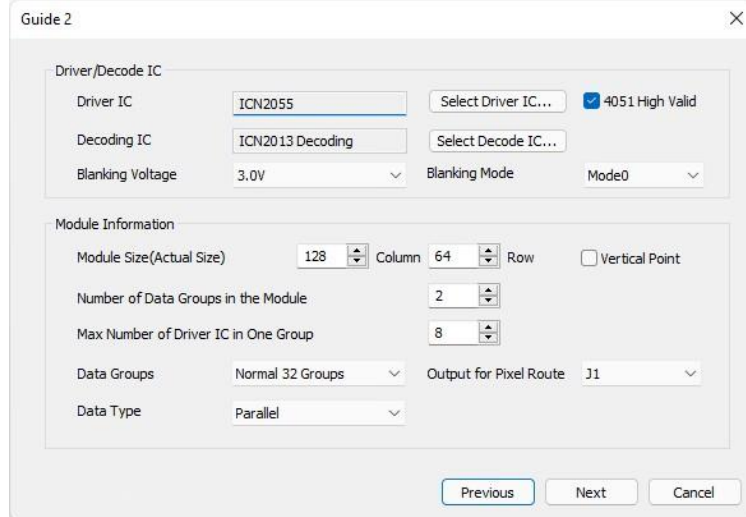

Fig 6.3.7.11 Guide 2 for multiple type module

The multiple type module functions are described as shown in Table 6.3.7-4.

Table 6.3.7-4 Multiple type module description

Feature	Description
Driver IC	Select the corresponding driver IC according to the module.
Decoding IC	Select the corresponding decoding IC according to the module.
Module size	Set the number of columns and rows of the module according to the actual size of the module.
Vertical point	Enable this function when the route of the module is in vertical direction.
Number of data groups in the module	Set the number of data groups in the module which is up to four.

Max number of driver IC in one group	Set the number of data group chips that occupy the most pixels in one scanning among all data groups in the module.
Data groups	Set the number of data groups output from the receiver card.
Output for pixel route	Select the physical J-port position of the receiver card displayed in the Intelligent Setting Effect interface.
Data type	Set the data type of the module, which supports three types: Parallel, Serial (R16G16B16) and Serial (R1G1B1).
Previous	Click the button to return to the previous Guide.
Next	Click the button to go to the next Guide.
Cancel	Click the button to cancel the intelligent settings.

➤ Guide 3

Set the data polarity of the modules, please refer to Single Type Module Guide 3 for details.

➤ Guide 4

Set the OE polarity of the modules, please refer to Single Type Module Guide 4 for details.

➤ Guide 5

Guide 5 is designed to set the signal output order of red, green, and blue from the video source to the physical pins of the receiver card. Refer to Single Type Module Guide 5 for more details.

➤ Guide 6

Set the height of individual data groups according to the number of rows displayed on the module. Refer to Single Type Module Guide 6 for more details.

➤ Guide 7

Guide 7 can be used to set the number of rows displayed for each scan of a single data group according to the number of rows on the module. Refer to Single Type Module Guide 6 for more details.

➤ Guide 8

Guide 8 is designed to set the trace information and route for a multiple type

module. The window is divided into a function bar and a drawing area.

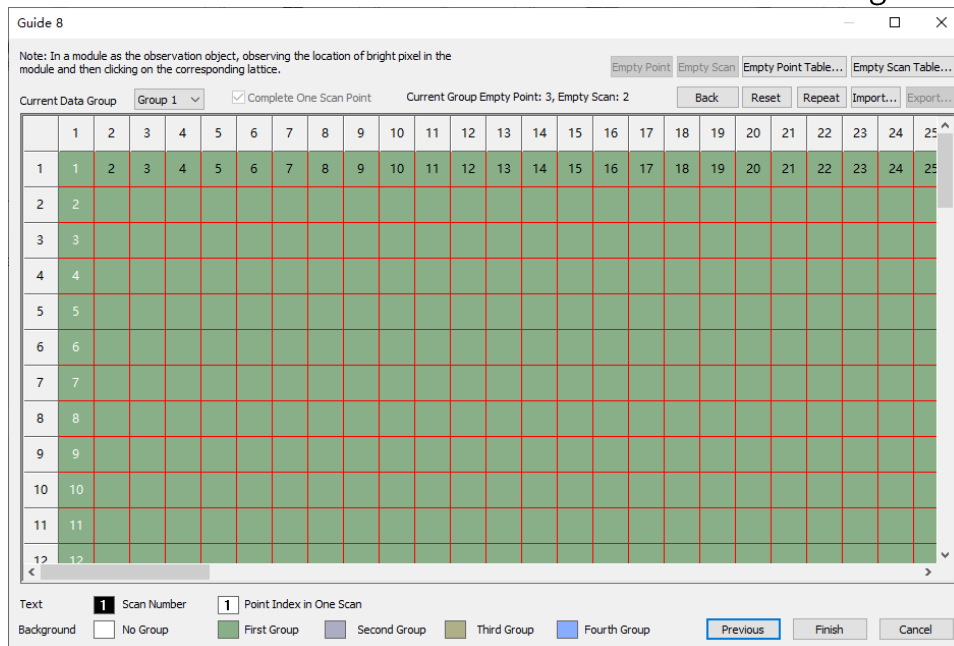

Fig 6.3.7.12 Multiple type module intelligent settings

- Current data group: Click the drop-down box to switch data groups and open the **Confirm Target Module** dialog box.

Step 1: Set the index of the current data group.

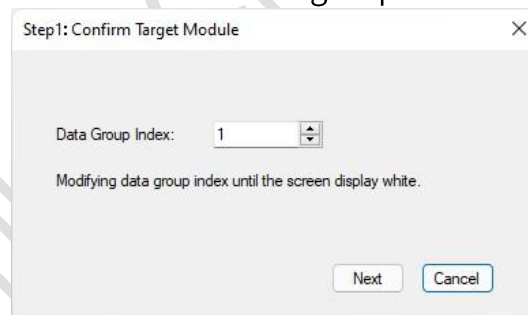

Fig 6.3.7.13 Confirm target module

Step 2: Input the number of corresponding ICs following the operation steps.

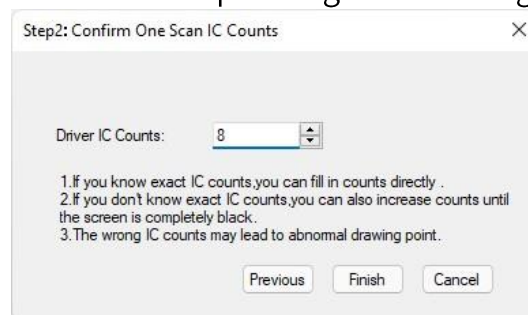

Fig 6.3.7.14 Confirm one scan IC counts

- Function Bar

The multiple type module function bar is described as shown in Table 6.3.7-5.

Table 6.3.7-5 Multiple type module function bar

Feature	Description
Complete one scan point	Tick the checkbox to complete the first scan point.
Empty point	Click the button to add an empty point to the current position.
Empty scan	Click the button to add an empty scan to the current position.
Empty point table	Click the button to open the Empty Point Setting popup window.
Empty scan table	Click the button to open the Empty Scan Setting popup window.
Back	Return to the previous step of point trace.
Reset	Click the button to reset the trace information of the current data group or all data groups.
Repeat	Copy the traces completed in the previous data group and apply them to the current data group.
Import	Click the button to import the local alignment table.
Export	After completing the trace, click the button to export the alignment table to a local file.
Previous	Click the button to return to the previous Guide.
Finish	Click the button to complete the intelligent settings and synchronize them to the basic parameter interface.
Cancel	Click the button to cancel the intelligent settings.

- Empty point setting: Configure the position and number of empty points for the First Scan and repeat the empty points for other scans.

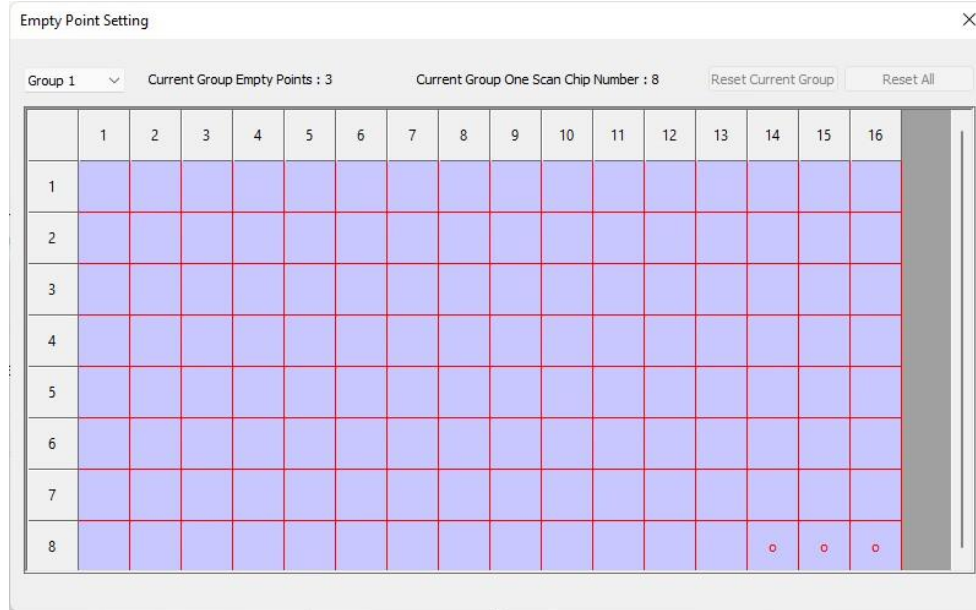

Fig 6.3.7.15 Empty point setting

The empty point setting function is described as shown in Table 6.3.7-6.

Table 6.3.7-6 Empty point setting function

Feature	Description
Data group	Select data groups.
Reset current group	Reset the empty point of the current data group.
Reset all	Reset empty points of all data groups.
Empty point drawing area	Set the position and number of empty points.

- Empty scan setting: Configure the position and number of empty scans for the data group.

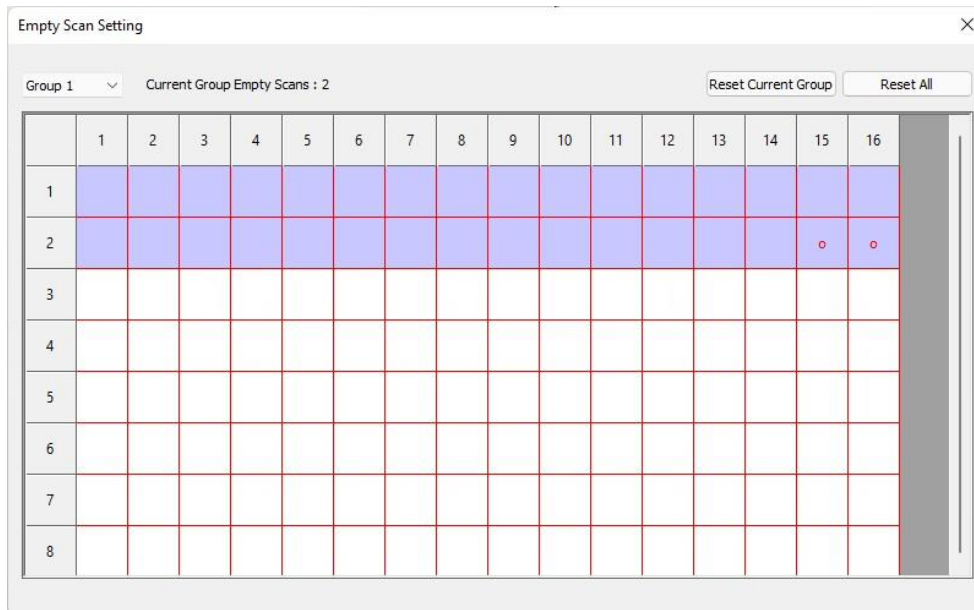

Fig 6.3.7.16 Empty scan setting

The empty scan setting function is described as shown in Table 6.3.7-7.

Table 6.3.7-7 Empty scan setting function

Feature	Description
Data group	Select data groups.
Reset current group	Reset the empty point of the current data group.
Reset all	Reset empty points of all data groups.
Empty point drawing area	Set the position and number of empty points.

- Drawing Area: It displays the trace information for the module. You can trace points following the “blinking dot” displayed on the module.
- Trace point: Before points are traced, click on the drawing area to trace points manually.
- Trace scan: After completing the first scan, click on the drawing area to trace the scans.

Shaped Module

➤ Guide 1

Click the intelligent settings button to enter Guide 1 and select **Shaped Module** as the cabinet type.

➤ Guide 2

In Guide 2, you can set the module size, and module information for the shaped type module.

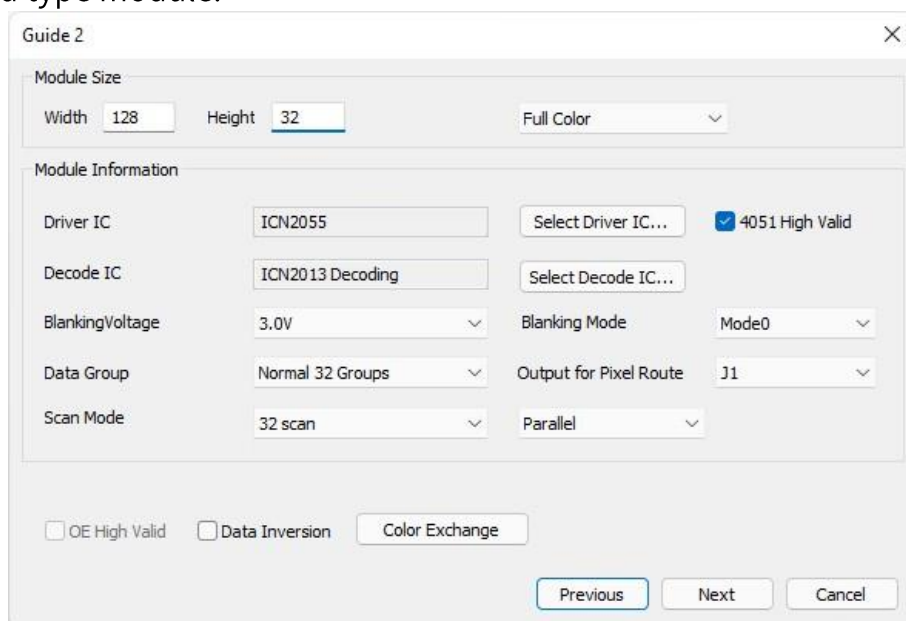

Fig 6.3.7.17 Guide 2 for shaped module

The shaped module Guide 2 features are described in Table 6.3.7-8.

Table 6.3.7-8 Guide 2 for shaped module function

Feature	Description
Module size	Set the width and height of the module.
Cabinet type	Support three cabinet types: full color, monochrome display, and dual color display.
Driver IC	Select the corresponding driver IC according to module.
Decode IC	Select the corresponding decode IC according to module.
Data group	Set the number of data groups to be output from the receiver card.
Output for pixel route	Select the physical J-port position of the receiver card shown in the Intelligent Setting Effect interface.
Scan mode	Set the number of scans for the module.
Data type	Set the data type of the module, which supports parallel, serial (R16G16B16) and serial (R1G1B1).

OE high valid	Set the OE polarity of the module.
Data inversion	Set the data polarity of the module.
Color exchange	Set the order of red, green, and blue signal outputs from the video source to the physical pins of the receiver card.
Previous	Click the button to return to the previous Guide.
Next	Click the button to go to the next Guide.
Cancel	Click the button to cancel the intelligent settings.

➤ Guide 3

After adding a route type, add a data group to the drawing area to construct the cabinet. The Guide 3 interface is divided into the route type and cabinet construction area.

Route Type

Route type is allowed to be added, edited, and viewed, and up to 128 types can be added.

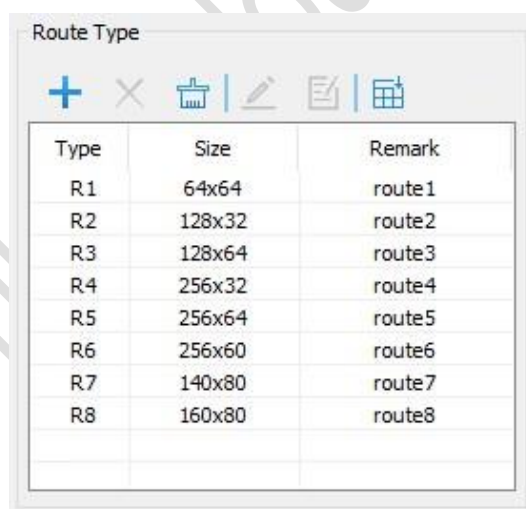

Type	Size	Remark
R1	64x64	route 1
R2	128x32	route 2
R3	128x64	route 3
R4	256x32	route 4
R5	256x64	route 5
R6	256x60	route 6
R7	140x80	route 7
R8	160x80	route 8

Fig 6.3.7.18 Route type list

- **+**: Click the button to open the **Add Module Type** dialog box. You can set the parameters of the route type, then click the **OK** button to enter the trace interface.

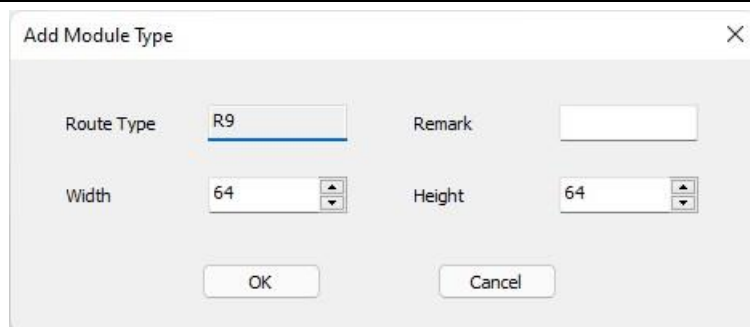







Fig 6.3.7.19 Add module type

- : Click the button to delete the selected route type.
- : Click the button to delete all route types.
- : Click the button to enter the trace interface of the selected route type.
- : Click the button to modify the remark of the selected route type.
- : Click the button to import the trace file of shaped screen and add a new route type to the list.
- List: Display the added route types and you can double click the route type to enter the trace interface.

Cabinet Structure Area

The interface can be divided into toolbar and drawing areas.







- Toolbar: The data groups in the drawing area can be added, deleted, aligned, or swapped, etc.







Fig 6.3.7.20 Toolbar of Guide 3

Toolbar is described as shown in Table 6.3.7-9.

Table 6.3.7-9 Toolbar description

Feature	Description
Data groups	Set the number of data groups output from receiver card.
	Click to undo the previous step.
	Click to redo the previous step.
	Add a data group to the drawing area.
	Delete the data group selected in the drawing area.
	Clear all data groups in the drawing area.
	Select multiple modules to align the module layout.

	Select multiple modules to number the modules.
	Click the button to enter the Data Group Swap window.
	Export the cabinet configuration parameters to a local file.
	Open the Help document.
Zoom	Zoom by switching the drop-down box options or the Ctrl + mouse wheel.

- Drawing area: Add and edit data groups to construct cabinets. Click Finish to complete the intelligent settings, which will be synchronized in basic parameters interface.
- Selected data group information: Select a data group and display the selected data group information on the left of the drawing area.

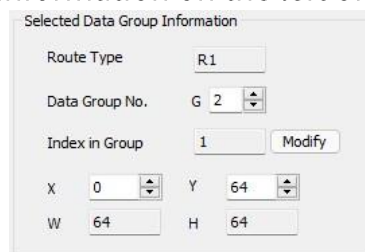

Fig 6.3.7.21 Selected data group information

Trace Interface





In Guide 2, you are allowed to choose **Parallel** as the **Data Type** to go to the parallel trace interface and choose **Serial** to go to the serial trace interface.



- Parallel trace interface: Trace the parallel modules and the software interface includes toolbar and drawing area.

■ Toolbar

A description of the parallel trace toolbar is shown in Table 6.3.7-10.

Table 6.3.7-10 Parallel trace toolbar

Feature	Description
	Undo the last action performed.
	Reset the trace in the drawing area.
	Verify the data group sequence number for the module and the number of ICs in one scan.
	When the trace is completed, click the button to export the

	alignment table as a local file. Support export directly or after rotation.
	Click the button to import the local alignment table.
Empty point	Click the button to add an empty point to the current position.
	Click the button to open the Empty Point Configuration dialog box.
Scan point by point	Once ticked, each point in one scan can be individually traced.
	Click the button to open the Help document.
OK	Click the button to complete the trace and synchronize with the list of route types.
Cancel	Click the button to cancel the trace.

■ Empty Point Configuration

If the **Scan Point by Point** is not selected, you can configure the position and number of empty points in the First Scan.

If the **Scan Point by Point** is selected, you can configure individual empty points for Each Scan.

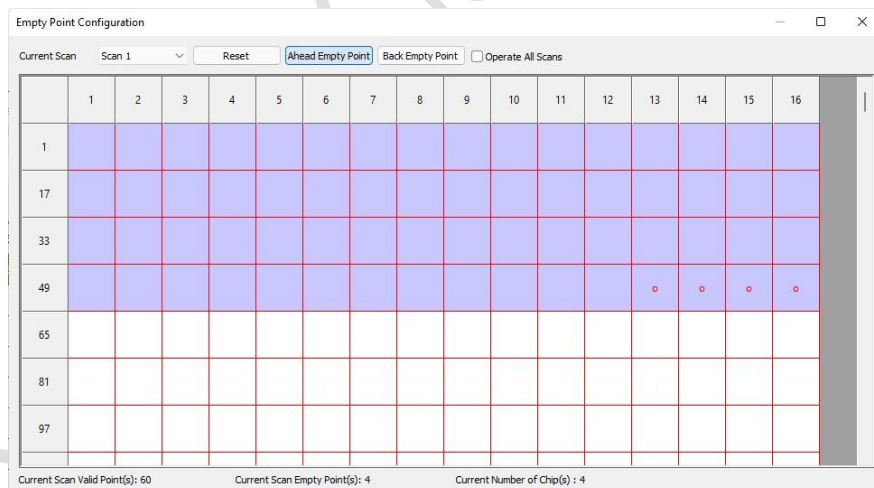



Fig 6.3.7.22 Empty point configuration

The empty point configuration features are described in Table 6.3.7-11.

Table 6.3.7-11 Empty point configuration function

Feature	Description
Current scan	Select the number of scans for empty point configuration.

Reset	Reset the empty points of the current data group.
Empty point drawing area	Click  to cancel empty point and click  to draw empty point.

- Drawing area: If **Scan Point by Point** is not selected, please refer to the single type module for the trace. If the **Scan Point by Point** is checked, you can configure individual points for each scan by switching **Current Scan**.

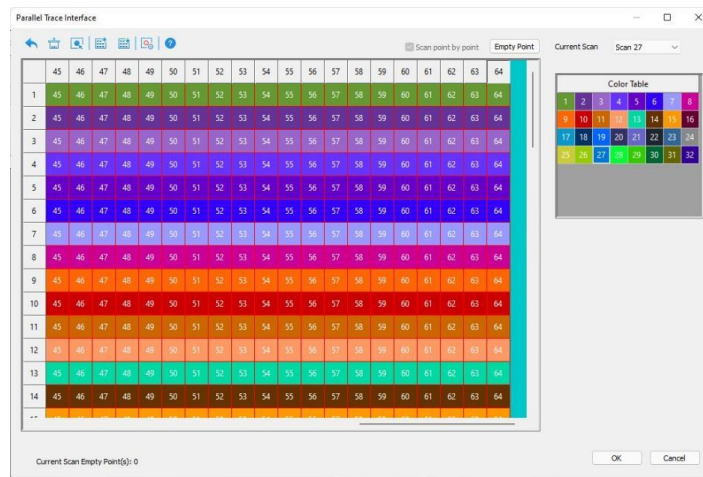

Fig 6.3.7.23 Drawing area

- Serial trace interface: Trace the serial module, please refer to the parallel module trace interface.

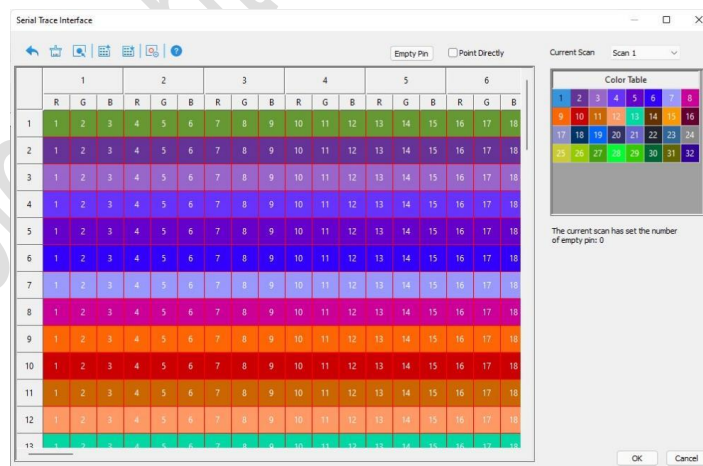

Fig 6.3.7.24 Serial trace interface

6.3.8 Function Button

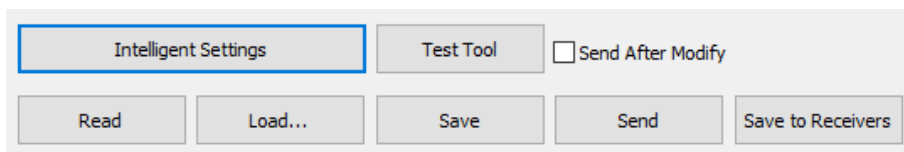

Fig 6.3.8.1 Function buttons

Function buttons are described as shown in Table 6.3.8-1.

Table 6.3.8-1 Function buttons

Feature	Description
Intelligent settings	Click the button to open Intelligent Settings , please refer to Chapter 6.3.7 for details.
Test tool	Click the button to open LEDTester , please refer to Chapter 7.
Send after modify	When checked, the modification of parameters will be sent to the receiver card in real-time.
Read	Read back the receiver card parameters and load them onto the software.
Load	Click the button to load the local parameter files.
Save	Save the display parameters as a local file.
Send	Send real-time parameters to the receiver card, which will be lost after power-off.
Save to receivers	Left click to save parameters to the receiver card, which will be valid after power-off.
	Right click to specify the receiver card saving and parameters readback.

Parameters Backup

Back up the display parameters. Enter “dkbf” in basic parameters interface to display the **Read Backup** and **Save to Backup** button.

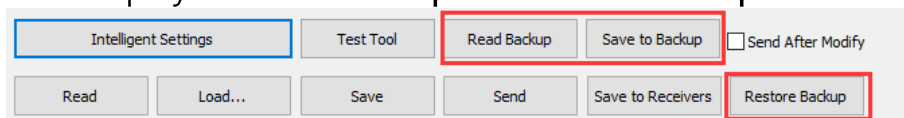

Fig 6.3.8.2 Parameters backup

The parameter backup features are described in Table 6.3.8-2.

Table 6.3.8-2 Parameter backup function

Feature	Description
Read backup	Left click to read back the parameters in the receiver card backup area.
	Right click to read back the parameters in the specified receiver card backup area.
Save to backup	Left click to save the parameters to the backup area of the receiver card.
	Right click to save the parameters to the backup area of the specified receiver card.
Restore backup	Left click to override the backup area parameters of the receiver card to the application area.
	Right click to override the backup area parameters of the specified receiver card to the application area.

Specify Receiver Card

According to the graphic location or list location, specify the receiver card firstly and do not close the **Specify Receivers Operation** dialog box. Then, you can perform intelligent settings, data group swap, sending parameters, saving parameters, read parameters and other specified receiver card operations.

In basic parameters interface, enter “zdjs” to display the **Specify Receivers** button. Click the button to open the **Specify Receivers Operation** dialog box, which is divided into two tabs **Graphic Location** and **List Location**.

- Graphic location: You are allowed to specify receivers using the graphic location.

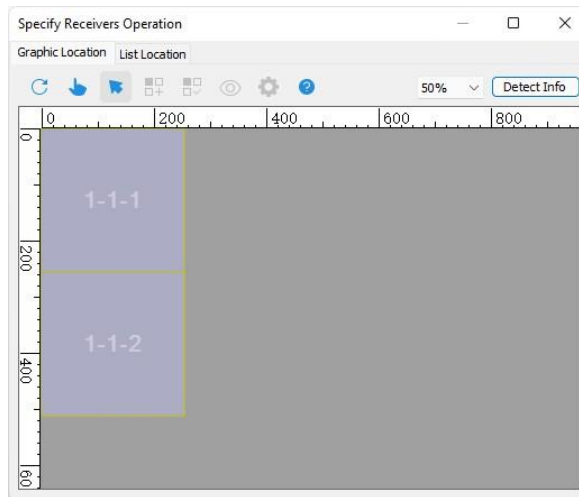

Fig 6.3.8.3 Graphic location

- List location: You can specify receivers by entering parameters in the list.

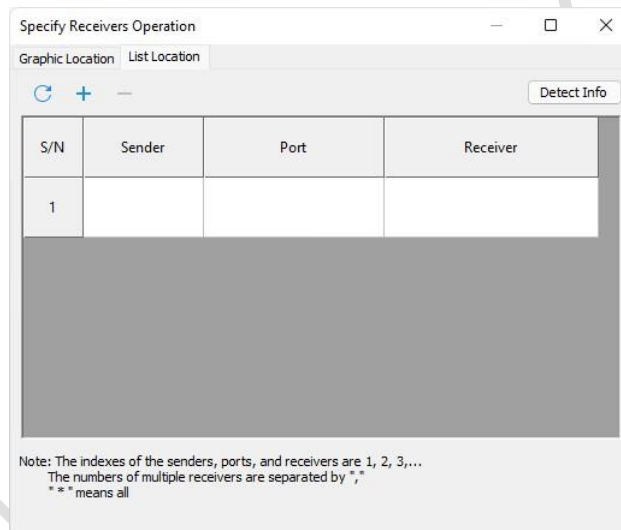



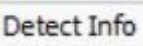

Fig 6.3.8.4 List location

Tab page of list location is described as shown in Table 6.3.8-3.

Table 6.3.8-3 Tab page of list location

Feature	Description
	Click to reset all information in the table.
	Click to add a row to the table.
	Click to reduce a row from the table.
	Detect information on all senders and receiver cards.

6.4 Connecting a Display

Set the mapping of the receiver cards that are connected to sender's ports according to cabinet count and physical connection mode with support for Standard and Complex mode.

Device List

Show cascading sender count, sender's Ethernet ports count, and Ethernet payload.

- Device: Switch a device and set its mapping.

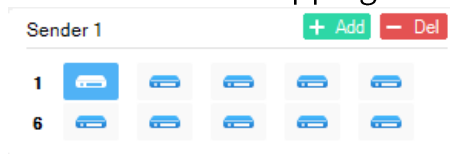

Fig 6.4.1 Device information

- Port: Switch Ethernet port and set its mapping.

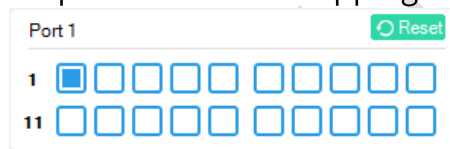

Fig 6.4.2 Port information

- Reset: Select to clear selected Ethernet port's mapping diagram.
- Load: Show the Ethernet payload of the selected device.

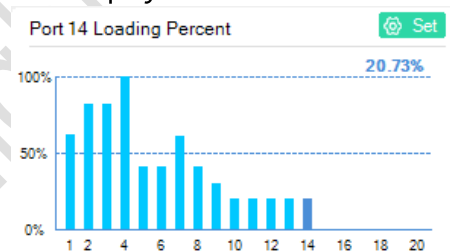

Fig 6.4.3 Ethernet payload

- Port Area Settings: Select to allow the **Port Area Settings** dialog box with support for Auto Calculation and Manual Edit.
- Auto Calculation: Calculate automatically sender's Ethernet port control area according to the mapping diagram.
- Manual Edit: Enter parameters manually to set sender's Ethernet port control area.

Sender	Port	X	Y	Width	Height
1	1	0	0	256	1536
1	2	256	0	512	1024
1	3	256	1024	512	1024
1	4	768	0	1280	512
1	5	768	512	256	1024
1	6	1024	512	512	512
1	7	1536	512	512	768
1	8	1024	1024	512	512
1	9	768	1536	768	256
1	10	2048	0	256	512
1	11	2048	512	256	512
1	12	1536	1280	512	256
1	13	1536	1536	512	256
1	14	2048	1024	256	512

Fig 6.4.4 Port area settings

6.4.1 Standard

Quick Start

Step 1: To add receiver cards to the drawing area, set **Receiver(s) Count** and **Selected Rcv Information** according to the actual cabinets (see Figure 6.4.1.1 below).

Receiver(s) Count

Col Count: 8

Row Count: 6

Reset All Select All

Selected Rcv Information

No.: 2

Width: 128

Apply to Column

Height: 128

Apply to Row

Fig 6.4.1.1 Add receiver(s)

Step 2: Draw each sender Ethernet ports' mapping diagram using Port Sorting and Receiver Sorting according to the actual mapping of receiver cards (see Figure 6.4.1.2 below).

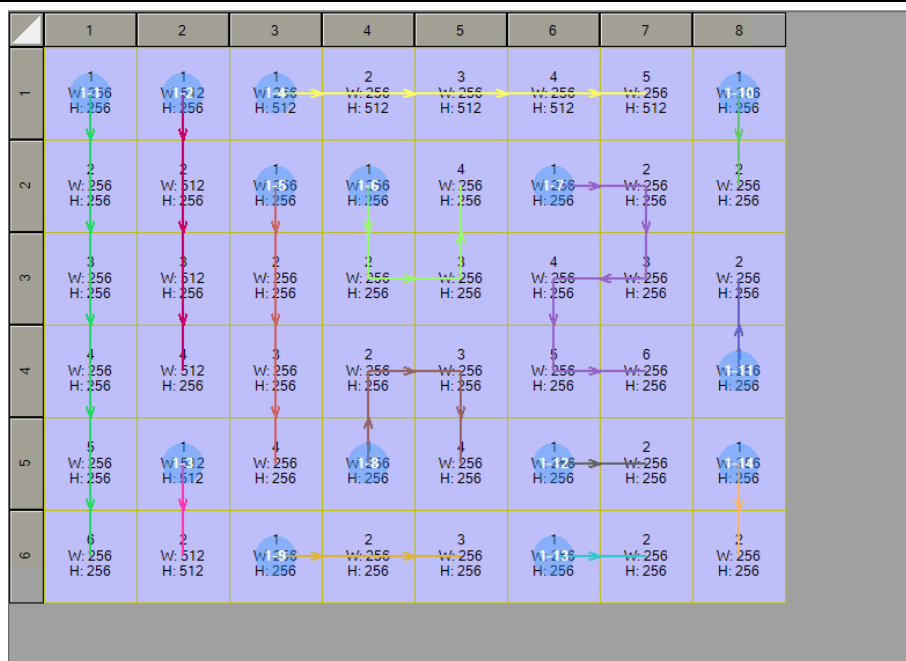

Fig 6.4.1.2 Mapping diagram

Step 3: Click **Send** and view the screen.

Toolbar

Set display' s mapping diagram using **Port Sorting**, **Receiver Sorting**, and **Demarcate**.





Fig 6.4.1.3 Standard - toolbar

For details of Standard toolbar, see Table 6.4.1-1.

Table 6.4.1-1 Standard toolbar

Function	Description
	Select to back.
	Select to undo last.
	Select to reset selected Ethernet port' s mapping diagram.
	Select to reset all Ethernet ports' mapping diagram.
	Select to reset the drawing area.
	Select from full screen sorting, port sorting, and sender sorting.
	Select to enable Beacon and demarcate selected receiver cards.
	Enable Normal Mode by default to control receiver cards in the drawing

	area.
	Select to set selected receiver cards to be void cards and disable mapping.
	Select a single receiver card, click the button, the Output Data Offset dialog box appears.
	Select to open the Help documentation.
Scaling	Zoom by selecting options from the drop-down menu, or holding Ctrl while scrolling mouse wheel.

- Output Data Offset: Ensure normal display using **Output Data Offset** to offset data output of receiver cards when cabinet modules are biased during the actual installation.

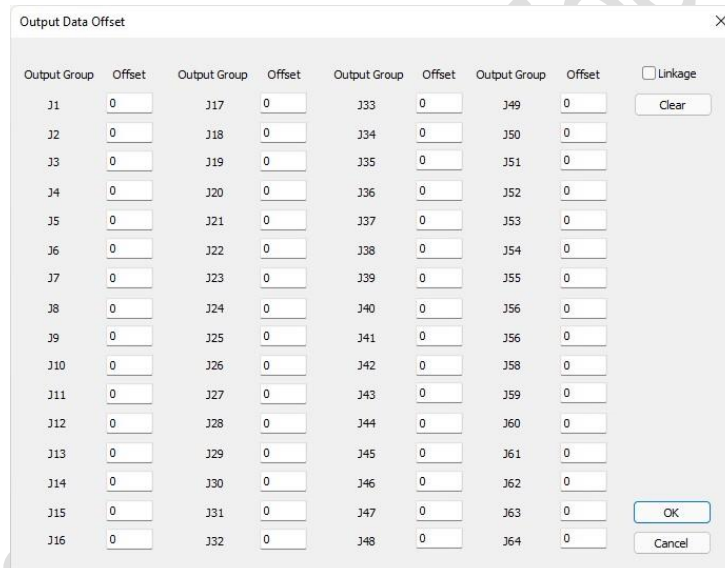

Fig 6.4.1.4 Output data offset

For more information about **Output Data Offset**, see Table 6.4.1-2.

Table 6.4.1-2 Output data offset

Function	Description
Output Group	J1-J64 Output Group.
Offset	Set pixels of offsetting output data.
Linkage	Select the Linkage checkbox to offset all output data.
Clear	Reset offset of all output data.
OK	Select to enable Output Data Offset .

Cancel	Close the Output Data Offset dialog box.
--------	---

Cabinet Configuration

Draw mapping diagram in the drawing area, and set receiver count and size.

- **Display Routing:** Select the **Display Routing** checkbox to show mapping diagram in the drawing area.
- **Receiver(s) Count:** Set the count of the receiver cards in the drawing area.

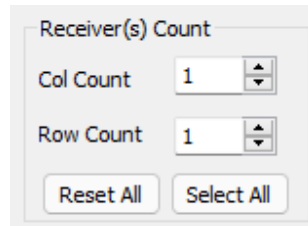

Fig 6.4.1.5 Receiver(s) count

- **Reset All:** Select to reset the count of receiver cards in the drawing area.
- **Select All:** Select all receiver cards in the drawing area.
- **Selected Receiver Information:** You can view the number of selected receiver cards and enter values in the width and height fields to do resizing.

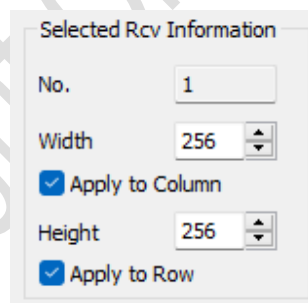

Fig 6.4.1.6 Selected receiver information

- **Apply to Column:** Select the **Apply to Column** checkbox, enter values in the width and height fields to apply them to all receivers in the column where the selected receiver card is located.
- **Apply to Row:** Select the **Apply to Row** checkbox, enter values in the width and height fields to apply them to all receivers in the row where the selected receiver card is located.
- **Layout Set:** Select the **Layout Set** button, select receiver cards in the drawing area to draw mapping diagram.

Drawing area

Drawing area shows all receiver cards' mapping diagram, size, and index. You can distinguish senders and Ethernet ports by colors and numbers. See the [Help](#) documentation to find out shortcuts of the drawing area.

6.4.2 Complex

Quick Start

Step 1: Select sender' s port according to actual cabinets, select **+** , set the position, count, size, and selected style of the receiver cards that are connected to corresponding Ethernet ports to draw mapping diagram (See Figure 6.4.2.1 below).

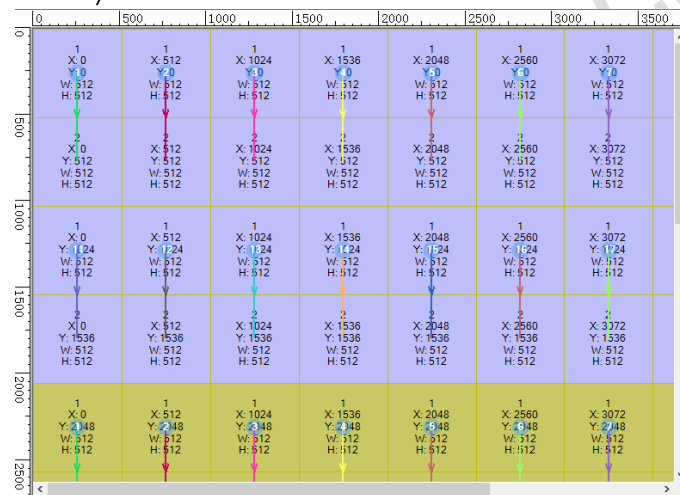

Fig 6.4.2.1 Mapping diagram

Step 2: Adjust parameters in cabinet configuration area on the right using **Port Sorting** and **Receiver Sorting**. Keeping receiver cards' mapping order and physical mapping order consistent.

Step 3: Click **Send** and view the screen.

Toolbar



Fig 6.4.2.2 Toolbar

- **+**: Select an Ethernet port, click the button to allow **Add Receiver(s)** dialog box, configure parameters, click **Add** to draw the port' s mapping

diagram.

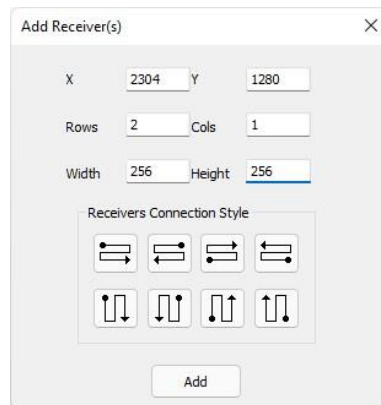





Fig 6.4.2.3 Add receiver(s)

- : Click the button to delete the selected receiver card in the drawing area.
- : Select and align multiple receiver cards.
- : Select and sort multiple receiver cards.
- Other functions: You can find out other functions in Standard - Toolbar.

Cabinet configuration area

Set the size and position of the selected receiver card.

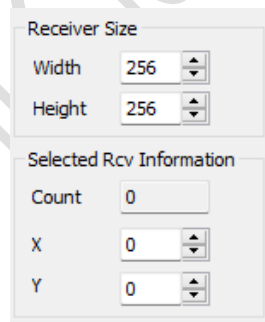

Fig 6.4.2.4 Cabinet configuration area

- Show Connection Lines: Select the Show Connection Lines checkbox to show mapping diagram in the drawing area.
- Receiver Size: Resize the selected receiver card.
- Selected Rcv Information: Show the count of the selected receiver card and set its position.

Drawing area

Drawing area shows all receiver cards' mapping diagram, position, size,

and index. You can tell senders and Ethernet ports by colors and numbers. See the **Help** documentation to find out shortcuts of the drawing area.

Function keys

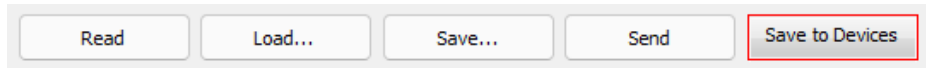

Fig 6.4.2.5 Function keys

To learn more about function keys, see Table 6.4.2-1.

Table 6.4.2-1 Function keys

Function	Description
Read	Read the receiver card' s mapping diagram and load it on LEDSetting.
Load	Click the button to load local parameter file of mapping diagram.
Save	Save receiver card' s mapping diagram as local files.
Send	Send real-time mapping diagram to all receiver cards to disable parameters when Restore Power Loss is enabled.
Save	Save parameters of mapping diagram to all receiver cards to enable parameters when Restore Power Loss is enabled.

7. Test Tool

Test LED display by entering parameters in the Test Tool to change display effect of the playback canvas in LEDSetting.

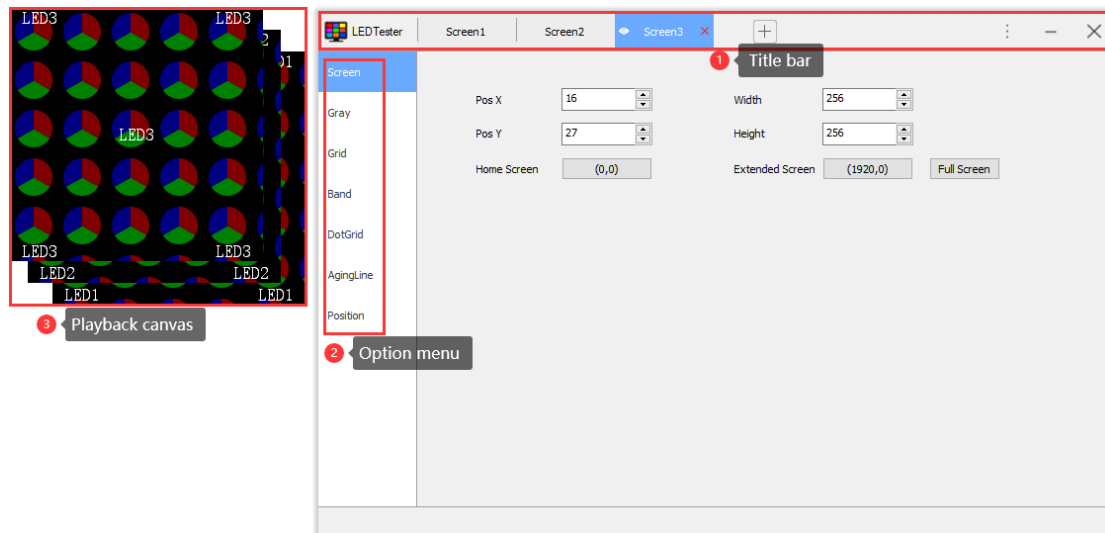







Fig 7.1 Test tool

- Title bar
 - Screen Management: Add, delete, switch screens. Show/Hide LEDSetting playback canvas.
 - Add Screen: Select  to add screens.
 - Delete Screen: Click  to delete the selected screens.
 - Screen Switching: Select screen name and switch to the corresponding screen from option menu to pin playback canvas.
 - Show/Hide Screen: Select  to hide the playback canvas, select  to show the playback canvas.
 - Shortcut menu: Select  to open the pop-up menu.

➤ Option menu

Screen

Adjust the position and size of LEDSetting playback screen.

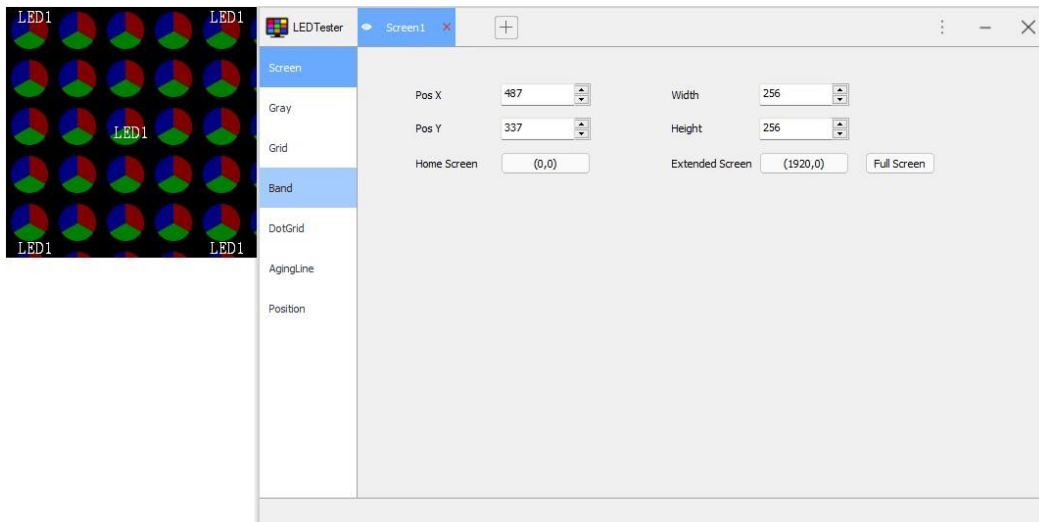

Fig 7.2 Screen

To know how to change screen settings, see Table 7-1.

Table 7-1 Screen settings

Parameter	Description
Pos X	Set the horizontal coordinate of the playback canvas.
Pos Y	Set the vertical coordinate of the playback canvas.
Width	Set the width of the playback canvas.
Height	Set the height of the playback canvas.
Home Screen	Click (0, 0) to set the coordinate of the playback canvas as (0, 0).
Extended Screen	Click (1920, 0) to set the coordinate of the playback canvas as (1920, 0).
Full Screen	Click Full Screen to set the size of the playback canvas to match your computer screen resolution.

Gray

Test LED display in solid color view.

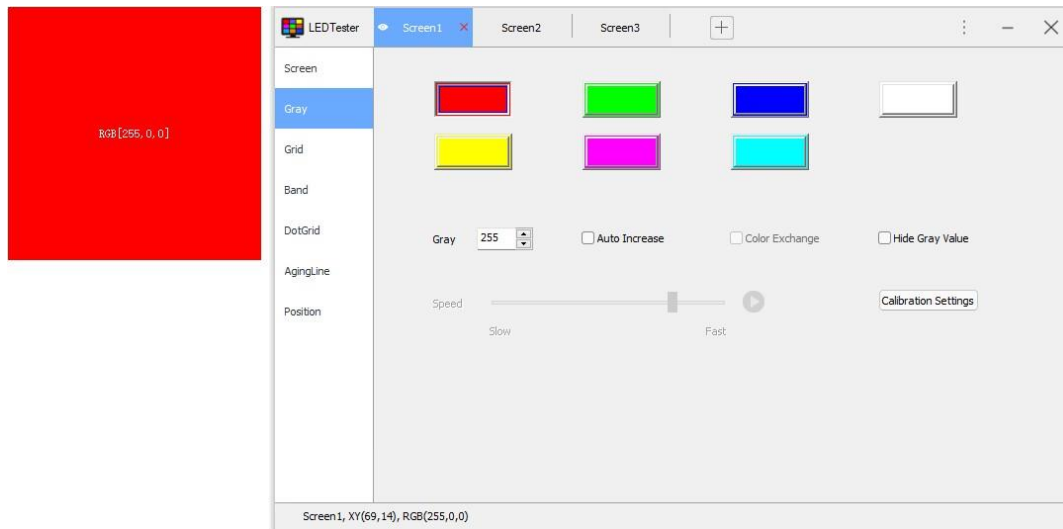



Figure 7.3 Gray

For detailed information about Gray, see Table 7-2.

Table 7-2 Gray

Parameter	Description
Color button	Click Red, Green, Blue, White, Yellow, Purple, or Cyan button to switch the color of the playback canvas.
Gray	Enter value in the field provided to adjust grayscale of the playback canvas.
Auto Increase	Select the checkbox, the grayscale of the playback canvas does cyclic increment automatically in the range of 0~255.
Color Exchange	Select the checkbox, the playback canvas switches the grayscale cyclic display sequentially in color order.
Hide Gray Value	Show/Hide gray value on of the playback canvas.
Speed	Adjust the speed of Auto Increase on the playback canvas, click  to enable Auto Increase.
Calibration Settings	Enable or disable calibration.

Grid

Test LED display in the Grid view.

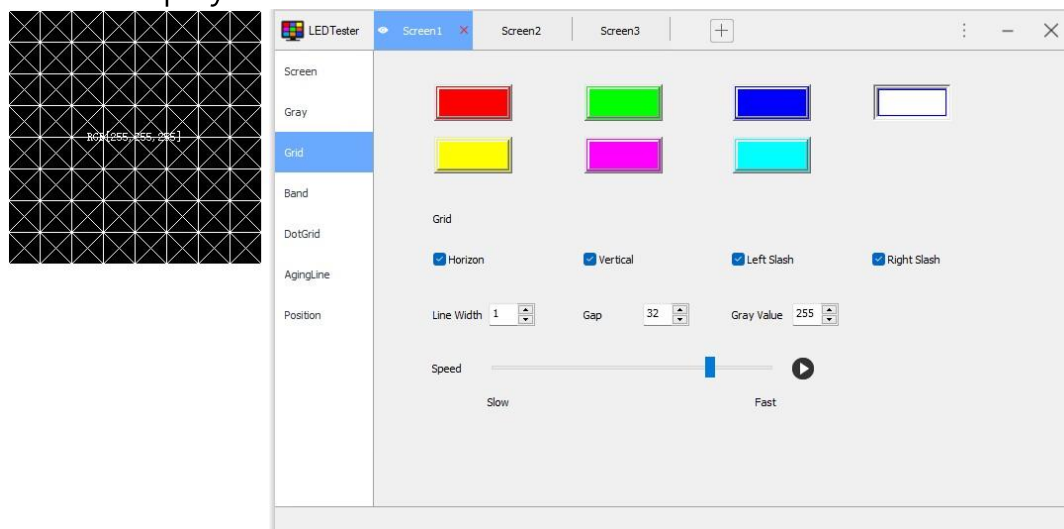



Fig 7.4 Grid

For details of Grid, see Table 7-3.

Table 7-3 Grid

Parameter	Description
Color button	Click Red, Green, Blue, White, Yellow, Purple, or Cyan button to switch the grid color of the playback canvas.
Horizon	Hide/Show grid horizontal lines of the playback canvas.
Vertical	Show/Hide vertical lines of the playback canvas grids.
Left Slash	Show/Hide left slash of the playback canvas grids.
Right Slash	Show/Hide right slash of the of the playback canvas grid.
Line Width	Enter values in the field to adjust the line width of the Screen grid.
Gap	Enter values in the field to adjust the gap of the Screen grid.
Gray Value	Enter values in the field to adjust the gray value of the Screen grid.
Speed	Move the slider to adjust the speed of the playback canvas grid movement, click  to move grid.

Band

Test LED display by setting screen gradient Band.

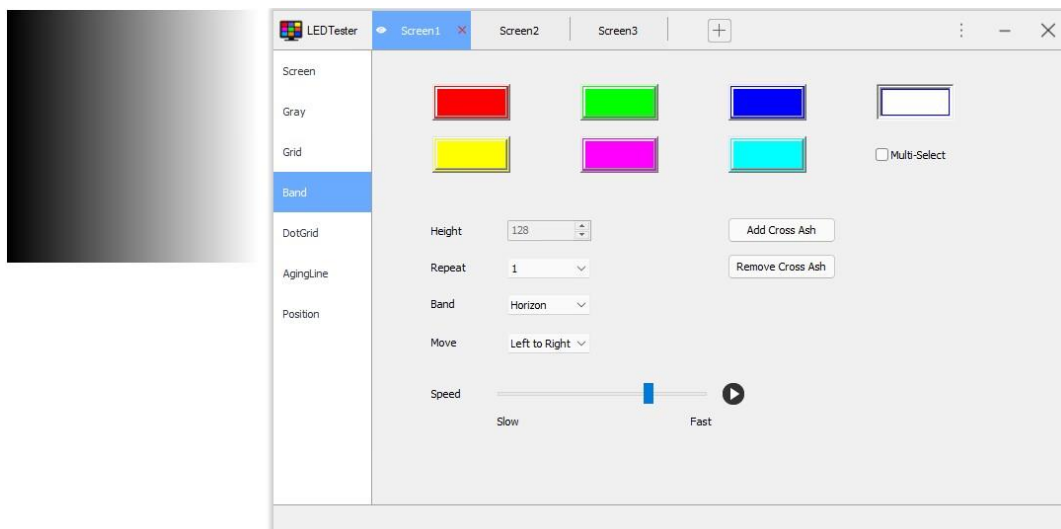



Fig 7.5 Band

For more information about Band, see Table 7-4.

Table 7-4 Band

Parameter	Description
Color button	Click Red, Green, Blue, White, Yellow, Purple, or Cyan button to switch band color of the playback canvas.
Multi-Select	Select the Multi-Select checkbox, simultaneously display multiple color bars on the playback canvas.
Height	Select the Multi-Select checkbox, enter values in the field to adjust band height.
Repeat	Toggle the drop-down box value to change the number of pixel points in the same grayscale of the tablecloth color bar.
Band	Horizon: Playback canvas band fades from left to right on a 0-255 gray scale. Vertical: Playback canvas band fades from top to bottom on a 0-255 gray scale.
Move	Select options from the drop-down menu to change the moving direction of the playback canvas band.
Speed	Move the slider to change the moving speed of the playback canvas band, and click  to start moving.
Add Cross Ash	Click Add Cross Ash , navigate over the playback canvas to add cross cursor markers.

Remove Cross Ash	Click Remove Cross Ash to clear cross cursor on the playback canvas.
------------------	---

Dot Grid

Test LED display by setting Dot Grid.

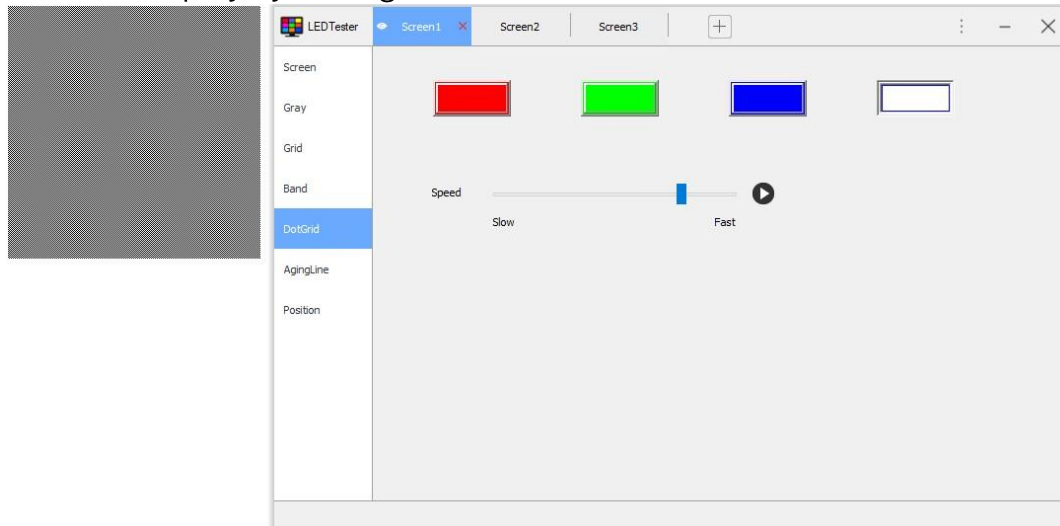



Fig 7.6 Dot grid

To learn more about dot grid, see Table 7-5.

Table 7-5 Dot grid

Parameter	Description
Color button	Click the Red, Green, Blue, White, Yellow, Purple, or Cyan button to switch the color of dot grid on the playback canvas
Speed	Move the slider to change the flickering speed of dot grid on the playback canvas, and click  to start flickering.

Aging Line

Test LED display by setting **Gray, Band, Grid, and Picture**.

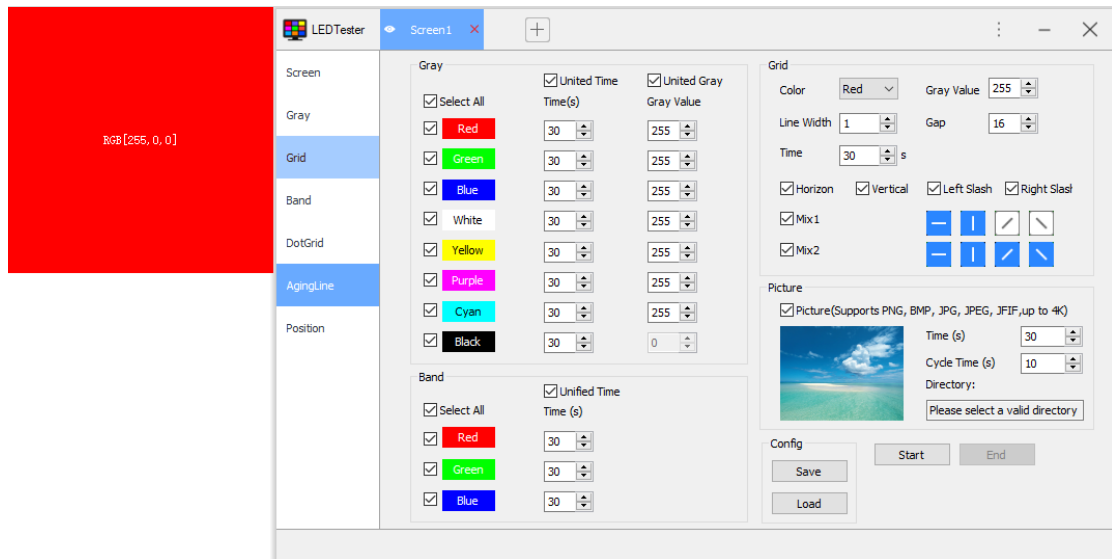

Fig 7.7 Aging line

To know how to configure aging line, see Table 7-6.

Table 7-6 Aging line

Parameter		Description
Gray	Color Options	Select the checkbox(es) to pick which grayscale color(s) will appear in the loop.
	Time(s)	Set the display time for each grayscale color. Or, select the United Time checkbox to apply the same display time to all grayscale colors.
	Gray Value	Set the gray value for each grayscale color. Or, select the United Gray checkbox to apply the same gray value to all grayscale colors (except black).
Band	Color Options	Select the checkbox(es) to pick which band color(s) will appear in the loop.
	Time(s)	Set the display time for each band color. Or, select the United Time checkbox to apply the same display time to all band colors.
Grid	Color	Select an option from the drop-down menu to change the color of the playback canvas grid.
	Gray Value/Line	Enter values in corresponding fields to adjust

	Width/Gap	gray value, line width, and gap of the playback canvas grid.
	Time	Enter a value in the field to adjust the time interval at which the grid line style switches on the playback canvas.
	Horizon/Vertical/Left Slash/Right Slash	Show/Hide playback canvas grid.
	Mix1/Mix2	Select and show multiple grid line styles.
Picture	Picture Option	Select the Picture checkbox to display one or more pictures in the loop.
	Picture Preview	Support preview of the first picture in the current directory. Click the preview picture to choose a new directory path. Once a new directory is selected, the display field will update to show the chosen path.
	Time(s)	Set the total display time for all pictures under the selected directory.
	Circle Time(s)	Set the display time for each picture under the selected directory.
Config	Save	Save the parameter settings from the AgingLine interface to a local file.
	Load	Load a local file to display the previously saved parameter settings on the AgingLine interface.
Start		Click to display the grayscale, band, grid, and picture sequentially based on the configured settings. During the loop, the Cycle Count and Cycle Time will be shown below the Start button.
End		Click to stop the loop.

Position

Configure parameters according to actual cabinets and module information,

mark the location of modules.

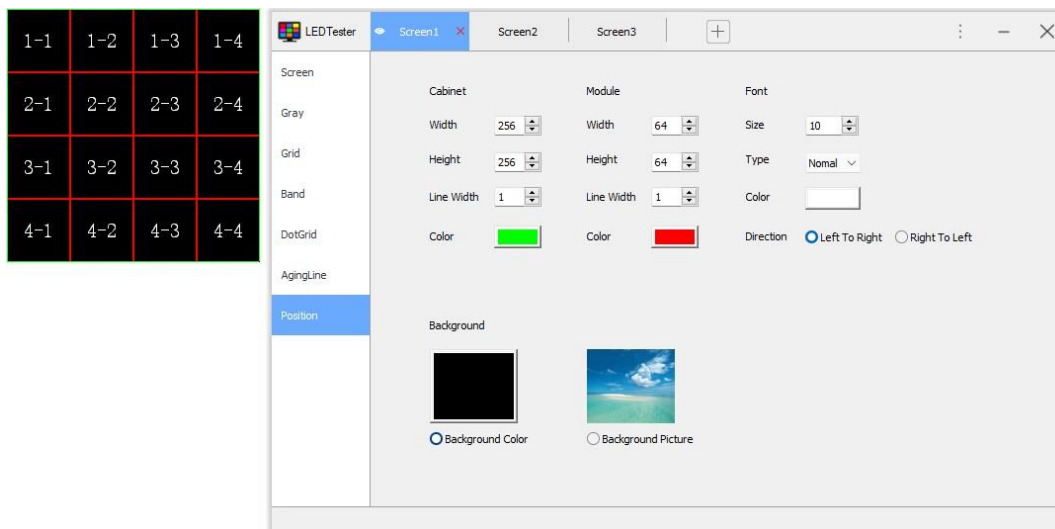

Fig 7.8 Position

For detailed information about Position, see Table 7-7.

Table 7-7 Position

Parameter	Description
Width	Set the width of cabinets and modules.
Height	Set the height of cabinets and modules.
Line Width	Set the line width of cabinets and modules.
Color	Set the color of cabinets and modules.
Size	Set the font size of module index.
Type	Set the font type of module index.
Color	Set the font color of module index.
Direction	Set the order of module index.
Background	Sets the screen background. Supports for solid color background and custom background.

➤ Context Menu

Right-click playback canvas to open context menu and do quick action.

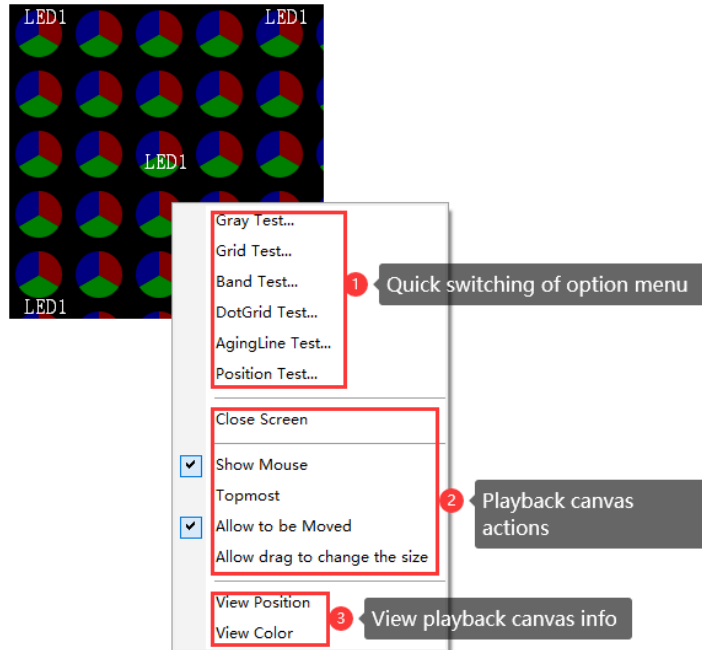

Fig 7.9 Context menu

- Quick switching of option menu: Click to switch option menu, and the screen switches to corresponding test mode.
- Screen operation: See Table 7-8 to learn about screen menu options.

Table 7-8 Menu Item

Menu Item	Description
Close Screen	Close playback canvas and delete corresponding screens in Test Tool.
Show Mouse	Select the Show Mouse checkbox to show cursor on the playback canvas.
Topmost	Select the Topmost checkbox to pin playback canvas.
Allow to be moved	Select the Allow to be moved checkbox and drag the position of the playback canvas with mouse.
Allow drag to change the size	Select the Allow drag to change the size checkbox and resize Screen by dragging Screen frame with mouse.

- Screen information viewing: Click options from the menu, navigate over the playback canvas to see the coordinate and color of the cursor.

8. Pixel-by-pixel Calibration

Title Bar

The title bar includes:

- An LEDSetting icon
- An interface title
- 4 Tabs: By Pixel, By Cabinet, By Module and Deseam
- An option to select either **Brightness Calibration** or **Chroma Calibration**
- 2 Buttons: Minimize and Close



Fig 8.1 Title bar

- Switch between Calibration Modes: Click the icon to quickly switch between **Brightness Calibration** and **Chroma Calibration**.

8.1 Quick Operations

8.1.1 Brightness/Chroma Calibration

Step 1: Go to the **By Pixel** tab and click **Getting Screen Information**, as shown in Figure 8.1.1.1.

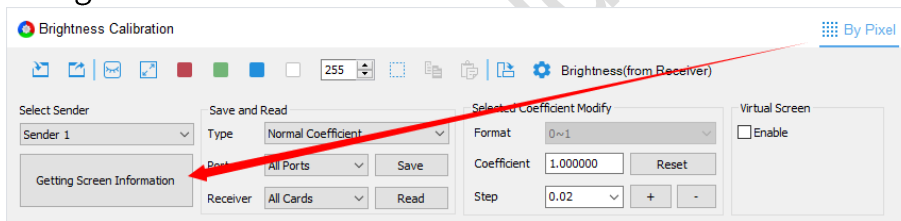

Fig 8.1.1.1 Getting screen information

Step 2: Click to set the size and coordinates of the calibration canvas according to the actual screen, as shown in Figure 8.1.1.2.

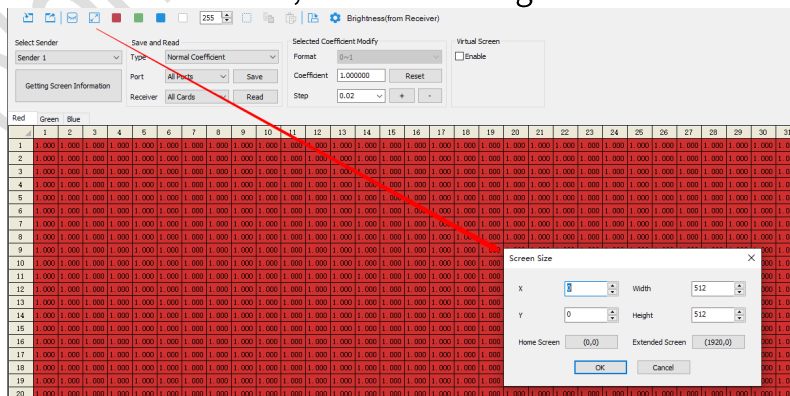

Fig 8.1.1.2 Set screen size and coordinates

Step 3: Click the **Import** icon to import brightness calibration coefficients. Alternatively, manually set coefficients in the coefficient adjustment area, as

shown in Figure 8.1.1.3.

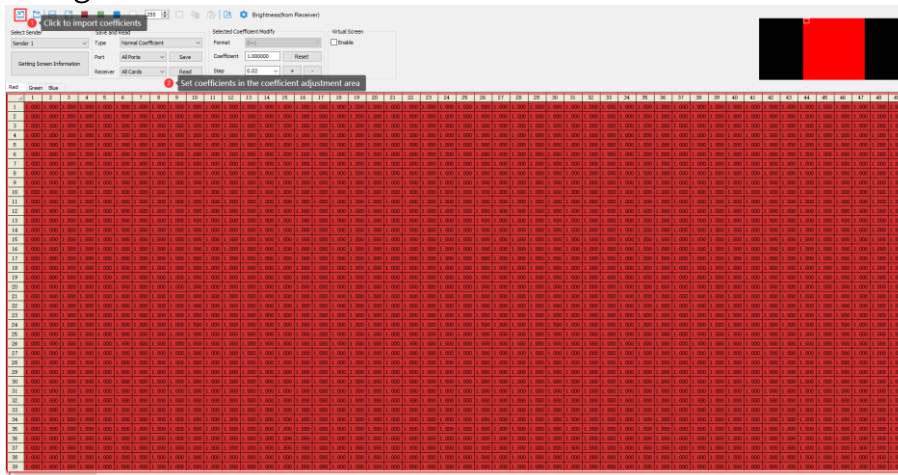



Fig 8.1.1.3 Set brightness calibration coefficient

Step 4: Click , and select **Set Calibration Switch** to open the **Calibration Settings** dialog box. Then, select the desired options under **Calibration Source** and **Calibration Mode**. As shown in Figure 8.1.1.4.

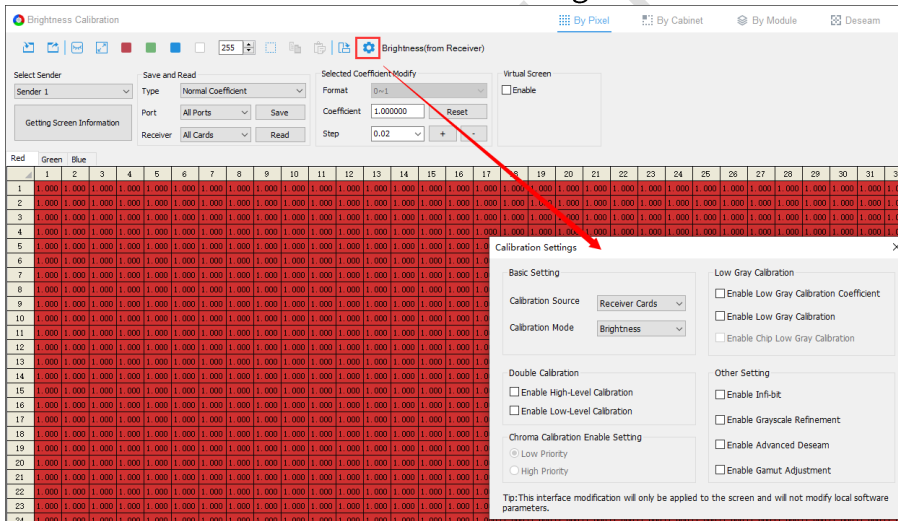

Fig 8.1.1.4 Enable brightness calibration of receiver card

Step 5: Select **Normal Coefficient** under **Save and Read**. Then, click **Save** to save the normal calibration coefficients, as shown in Figure 8.1.1.5.

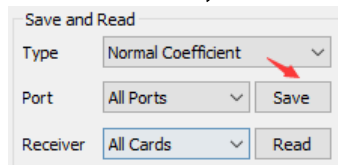



Fig 8.1.1.5 Save calibration coefficient

Step 6: Check the screen and enable calibration.

8.1.2 Gradient Adjustment

Step 1: Go to the **By Cabinet** tab and click **Getting Screen Information**.

Step 2: Click  to set the size and coordinates of the calibration canvas according to the actual screen.

Step 3: Click **Read** to retrieve the calibration coefficients, and select the receiver card you want to adjust the gradient for. Right-click the selected receiver card to open the context menu, then select **Gradient Adjustment**.

Step 4: Under **Gradient Adjustment**, enter the desired coefficient value. Click the **Apply Gradient** button to save the new coefficient values, as shown in Figure 8.1.2.1.

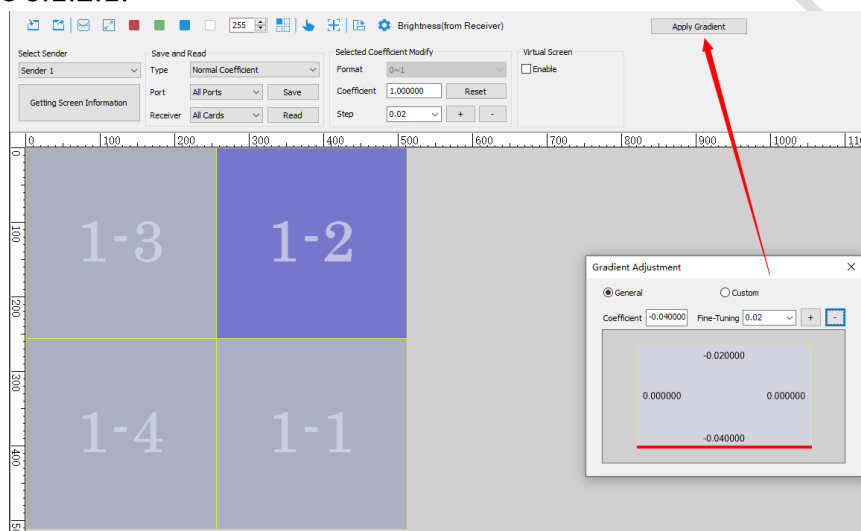



Fig 8.1.2.1 Set gradient adjustment coefficients

Step 5: Click , and select **Set Calibration Switch** to open the **Calibration Settings** dialog box. Then, select the desired options under **Calibration Source** and **Calibration Mode**.

Step 6: Under the **Save and Read** settings, select **Normal Coefficient** from the **Type** drop-down menu. Then, click **Save** to save the normal calibration coefficients, as shown in Figure 8.1.2.2.

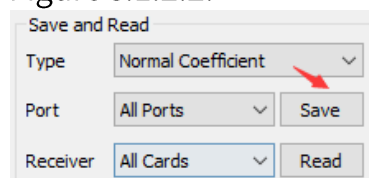

Fig 8.1.2.2 Save gradient adjustment coefficients

Step 7: Check the screen and enable calibration to view the effect after gradient adjustment.

8.1.3 Deseam

Step 1: Go to the **Deseam** tab and click **Getting Screen Information**.

Step 2: Click to set the size and coordinates of the calibration canvas according to the actual screen.

Step 3: Click to open the **Module Size** dialog box. Select the **Enable Module** checkbox, then set the module size as required. As shown in Figure 8.1.3.1.

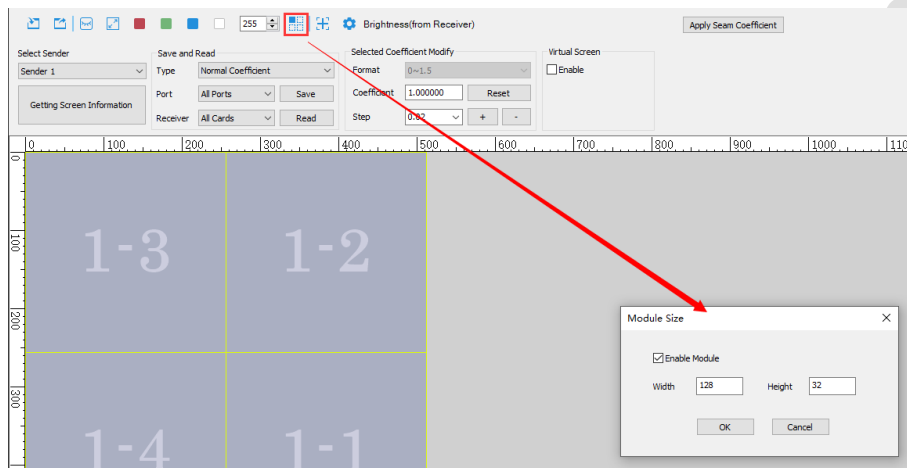

Fig 8.1.3.1 Set module size

Step 4: Click **Read** to retrieve the calibration coefficients, and select a seam. Under **Selected Coefficient Modify**, set coefficients as required. Then click **Apply Seam Coefficient** to save the new coefficient value for the selected seam, as shown in Figure 8.1.3.2.

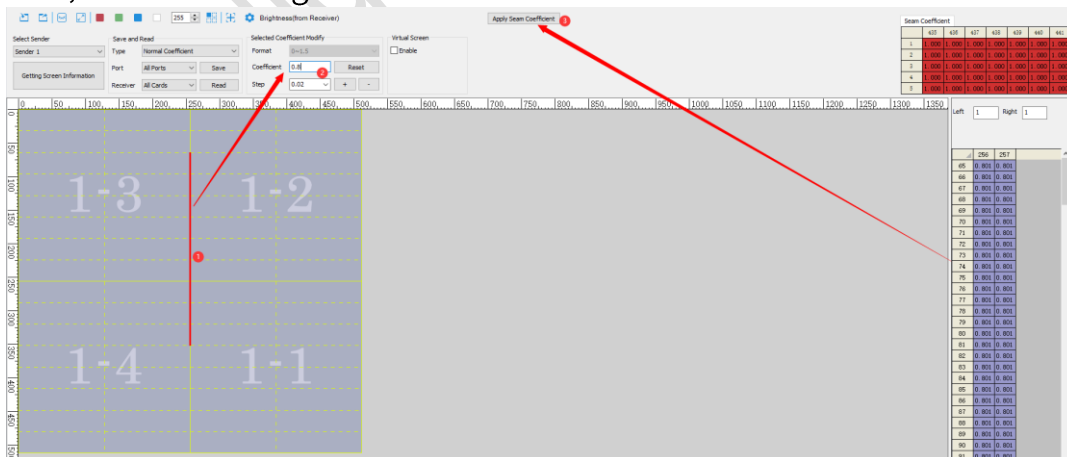

Fig 8.1.3.2 Set seam coefficient

Step 5: Click , and select **Set Calibration Switch** to open the **Calibration Settings** dialog box. Then, select the desired options under **Calibration**

Source and Calibration Mode.

Step 6: Under the **Save and Read** settings, select **Normal Coefficient** from the **Type** drop-down menu. Then, click **Save** to save the normal calibration coefficients, as shown in Figure 8.1.3.3.

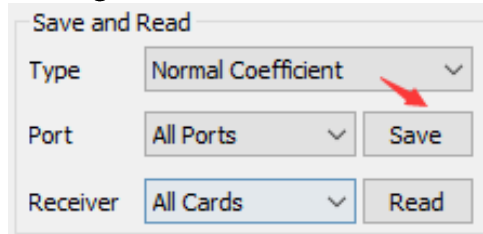

Fig 8.1.3.3 Save seam coefficient

Step 7: Check the screen and enable calibration to view the effect after seam adjustment.

8.2 Brightness Calibration

Brightness Calibration ensures highly consistent calibrated brightness of the screen by adjusting the brightness of the LED display. During adjustment, the maximum brightness of most LEDs needs to be lowered to an appropriate level. The brightness calibration coefficient has 3 components: R, G, and B.

8.2.1 By Pixel

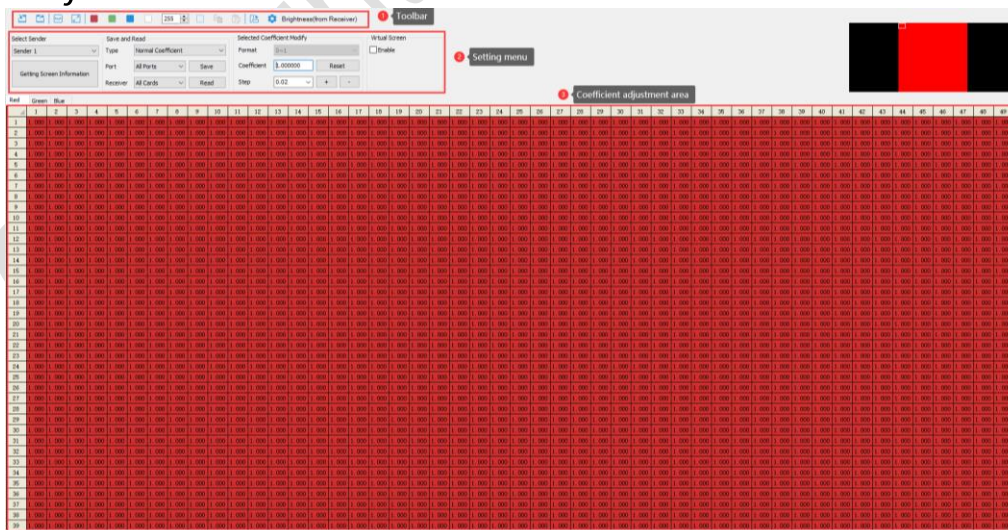

Fig 8.2.1.1 By Pixel

Toolbar

: Click to open the drop-down menu, and select a desired option to import

a local calibration coefficient file.

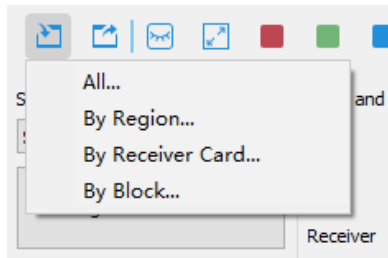

Fig 8.2.1.2 Import

The available options in the **Import** drop-down menu are described in Table 8.2.1-1 below.

Table 8.2.1-1 Description of options in import drop-down menu

Option	Description
All	Import all calibration coefficients, which will be automatically cropped to match the calibration canvas size.
By Region	Set initial coordinates and import the coefficients to the specified position.
By Receiver Card	Import the calibration coefficients by receiver cards. The results will be displayed in the list.
By Block	Import the calibration coefficients by block. The imported coefficients will be assigned to their matching areas.

- Procedures for Importing by Block
- Step 1: Click to load a coefficient file, as shown in Figure 8.2.1.3.

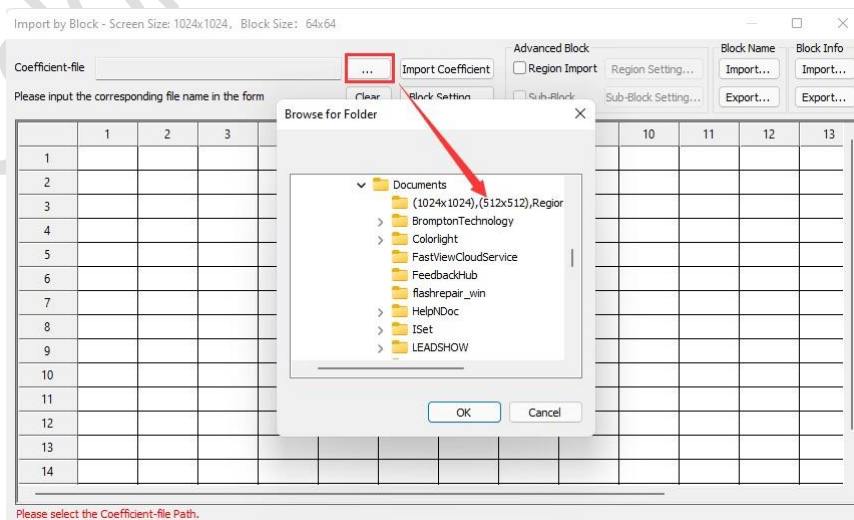

Fig 8.2.1.3 Load a coefficient file

- Step 2: Enter parameter values in **Block Setting**, **Region Setting**, and **Sub-Block Setting** respectively, as shown in Figure 8.2.1.4.

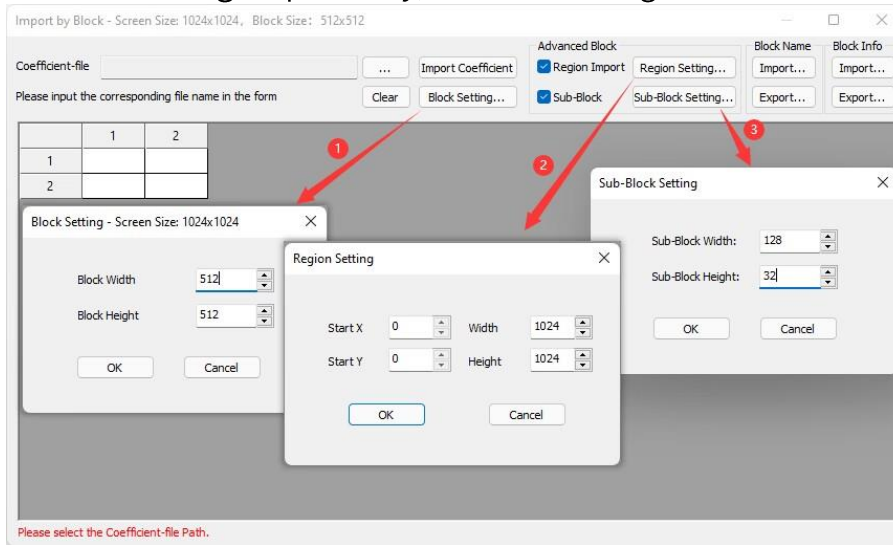

Fig 8.2.1.4 Set blocks

Notes:

- If the coefficient file you are loading contains certain regions or sub-blocks, the Region Setting and Sub-Block Setting must be set.
- The block width and height cannot be larger than the coefficient file's block size.
- The sub-block width and height cannot be smaller than the coefficient file's sub-block size.

- Step 3: Click the **Import** button under **Block Name** or **Block Info** to import relevant files. Then click **Import Coefficient**, as shown in Figure 8.2.1.5.

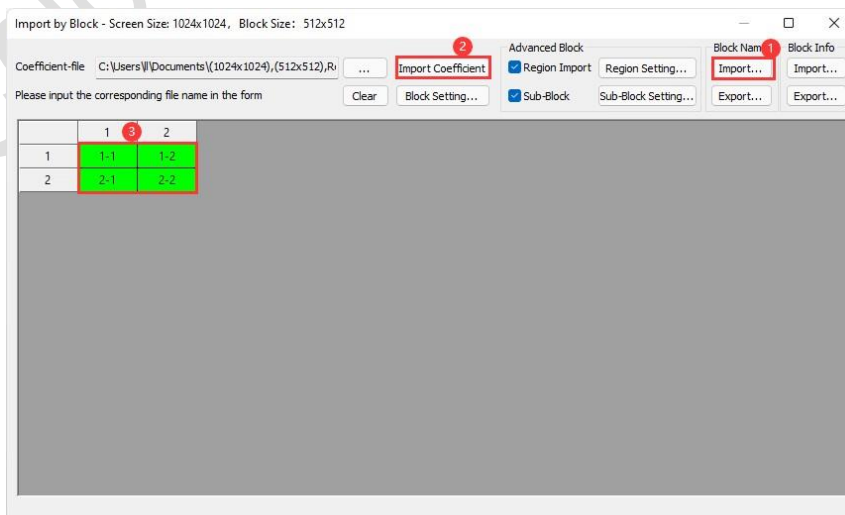



Fig 8.2.1.5 Import coefficients

 Note:

Successfully imported areas will have a green grid background; areas where import failed will have a red grid background.

: Click to open the drop-down menu, and select a desired option to export the calibration coefficients to a local file.

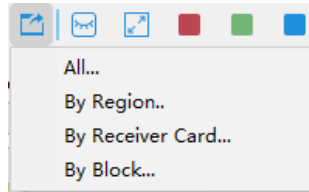





Fig 8.2.1.6 Export

The available options in the **Export** drop-down menu are described below in Table 8.2.1-2.

Table 8.2.1-2 Description of options in export drop-down menu

Option	Description
All	Export all coefficients.
By Region	Export the coefficients from a selected region.
By Receiver Card	Export all coefficients by receiver card, with the coefficient file name being “Port Index - Rcv Index” .
By Block	Click By Block to open the dialog box. Set the block parameters and export the block coefficients to a local file.

: Click  to show calibration canvas, and click  to hide calibration canvas.

: Click the icon to open the **Screen Size** dialog box, and enter parameter values to adjust the size and coordinates of the calibration canvas.

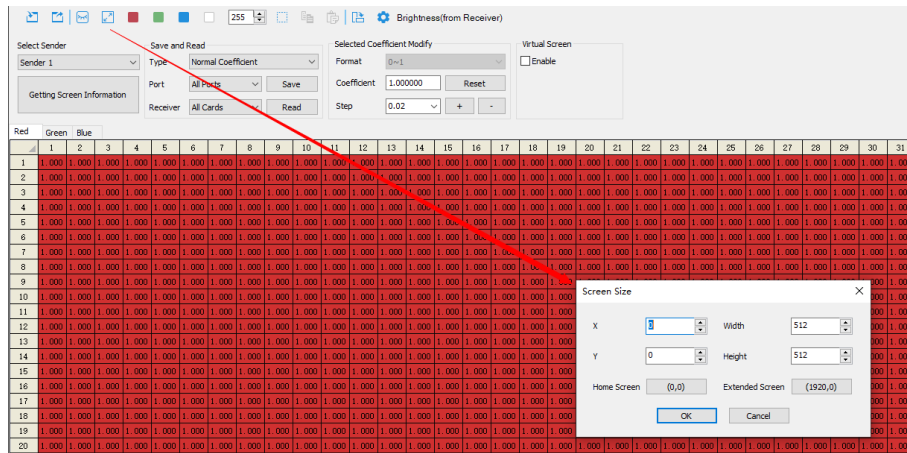

Fig 8.2.1.7 Set screen size and coordinates

: Click to switch the corresponding color for the calibration canvas.

255: Enter values in the input field to adjust the grayscale of the calibration canvas.

: Click to open the Region Select dialog box, and enter values in the coordinate and size fields. Then, choose a region to apply the configuration.

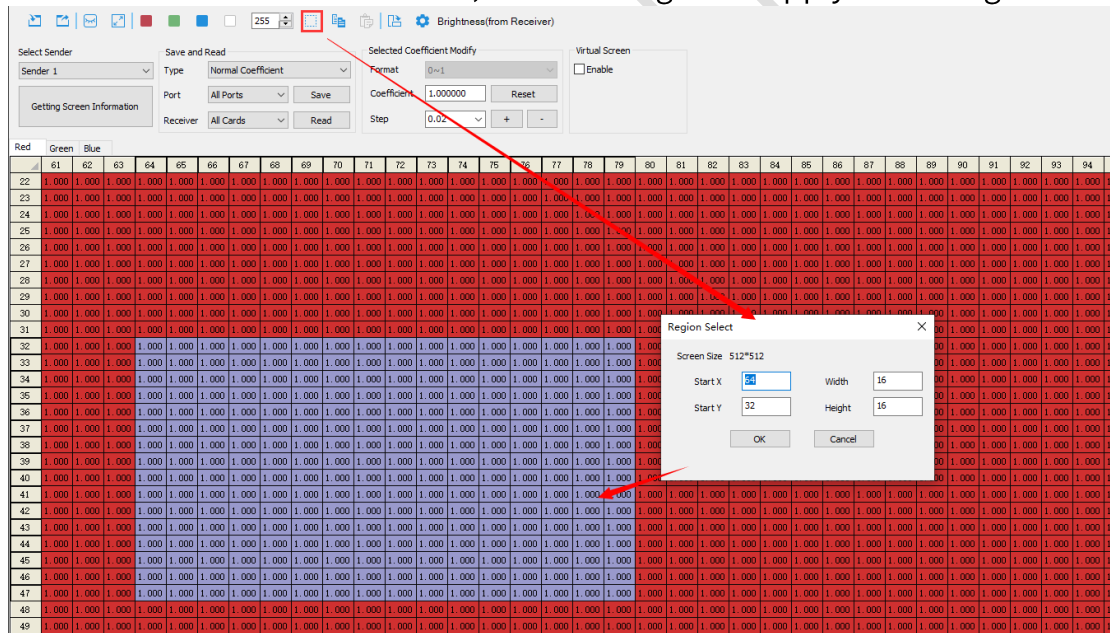

Fig 8.2.1.8 Region select

: Select a desired coefficient adjustment region. Click this icon to copy the real-time coefficients of the selected region.

: After copying the coefficients, click this icon to paste the copied real-time coefficients.

: Click to open the Rotate Calibration Coefficient dialog box. Select a desired rotation option:

- To rotate one file, click **Rotate One File** and select a coefficient file.
- To rotate multiple files, click **Batch Rotation** and select a coefficient folder.

Click **OK** to generate a new coefficient file with the selected rotation applied.

- The size of the coefficient file must match that of the current screen.

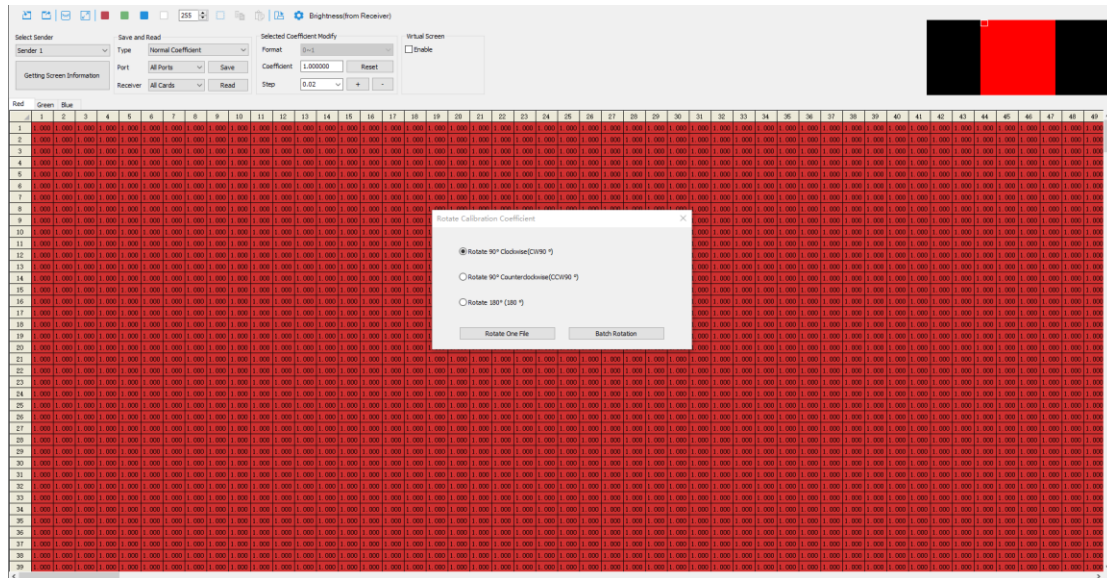

Fig 8.2.1.9 Rotate calibration coefficient

: Click to configure **Calibration Settings**. The calibration status will be displayed on the right side of the icon.

- Getting Screen Information: Before clicking this button, the status of **Disable Calibration** is displayed; after clicking it, the options of **Calibration Mode** and **Calibration Source** are displayed for the current LED screen.
- : Click this icon to open a drop-down menu with 2 options: **Set Calibration Switch** and **Enable Simulation by PC**.
- **Set Calibration Switch**: Click to open the **Calibration Settings** dialog box. Enable calibration based on your requirements.

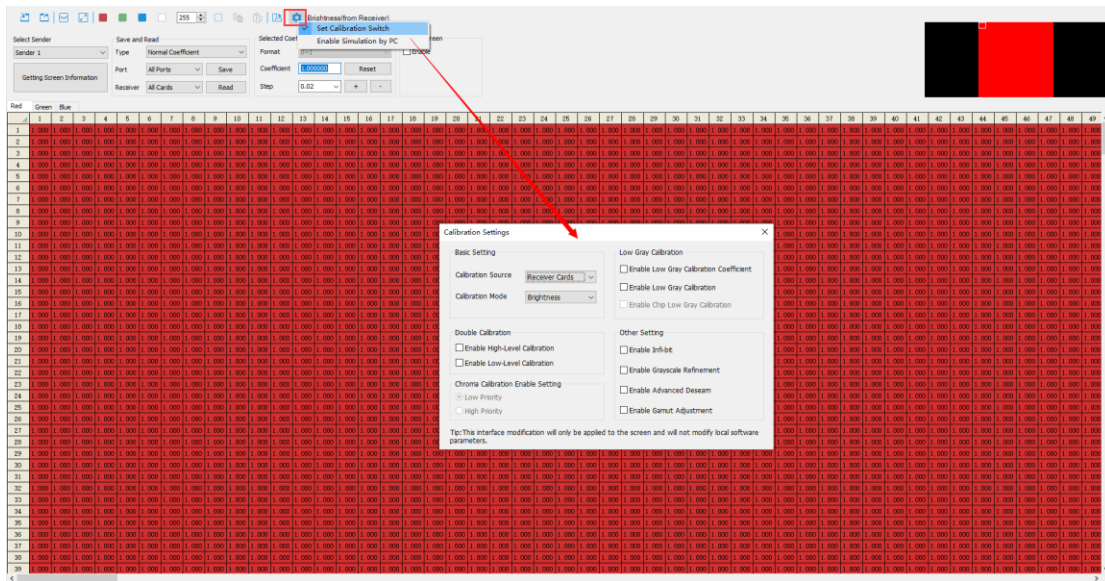

Fig 8.2.1.10 Calibration settings

- **Enable Simulation by PC:** Select this option to view a simulated image on the calibration canvas according to the calibration coefficients set in the coefficient adjustment area.

Settings Menu

- **Select Sender**
- **Select Sender:** Select a sender as required from the drop-down menu.
- **Getting Screen Information:** Click this button to get screen information.

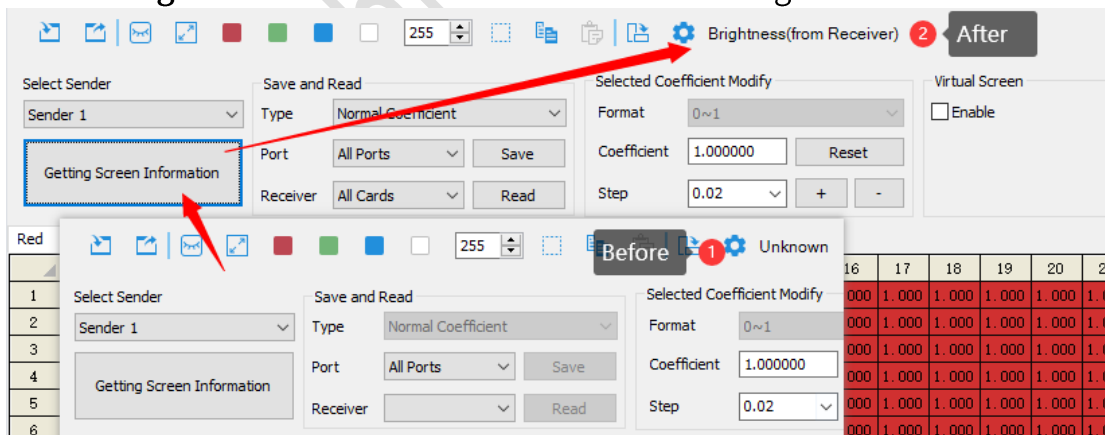

Fig 8.2.1.11 Getting screen information

- **Save and Read**
- **Type:** Toggle between calibration coefficient types.
- **Port:** Select a port from the drop-down menu.
- **Receiver:** Select a receiver card from the drop-down menu.

- **Save:** Save calibration coefficients to the receiver card.
- **Read:** Read calibration coefficients from the receiver card and load them into the software.
- **Selected Coefficient Modify**
- **Format:**
- ◆ When **Normal Coefficient** or **Low Level Coefficient** is selected as the **Type**, the **Format** is set to 0~1 by default. The **Format** field will be grayed out and not changeable.
- ◆ When **Low Brightness Coefficient** is selected as the **Type**, select a format from the **Format** drop-down menu to display the calibration coefficient.

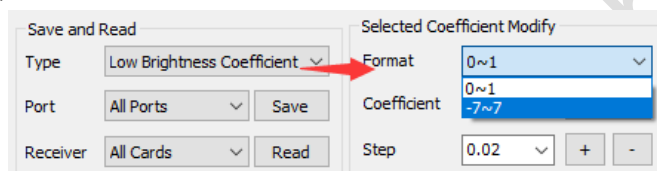

Fig 8.2.1.12 Set format for low brightness coefficient

- ◆ When **Chip Low Brightness Coefficient** is selected as the **Type**, select an option from the **Format** drop-down menu to change the format of the calibration coefficients.



Fig 8.2.1.13 Set format for chip low brightness coefficient

📖 Notes:

1. When changing the Format from 0~1 to -7~7, the following formula is used for coefficient conversion:

$$\text{Extended coefficient} = (\text{Original coefficient} - 0.5) * 14$$

2. When changing the Format from 0~1 to 0~63, the following formula is used for coefficient conversion:

$$\text{Extended coefficient} = \text{Original coefficient} * 64$$

(When the Format is set to 0~63, each adjustment of the coefficient will increase or decrease the value by 1. The result will be rounded to the nearest integer.)

- **Coefficient:** Modify the coefficient in the input field; click **Reset** to reset

all coefficients to their default values.

- **Step:** Modify the step in the input field or select a value from the drop-down options to adjust the fine-tuning step, then click **+** or **-** to adjust the selected coefficients.

● **Virtual Screen**

Procedures

Step 1: Select the **Enable** checkbox to turn on virtual screen calibration. This will display the **Lighting Rules** and **Virtual Green** buttons in the interface, as well as the **Virtual Green** tab as shown in Figure 8.2.1.14.

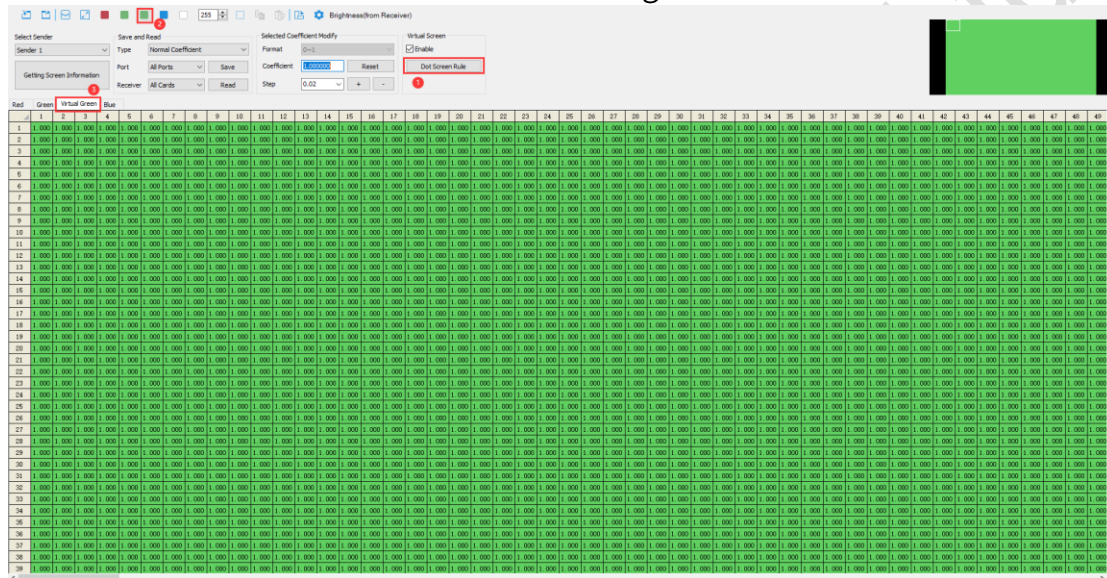

Fig 8.2.1.14 Enable virtual screen

Step 2: Click **Lighting Rules** to open the dialog box and select one of the lighting rules as shown in Figure 8.2.1.15.

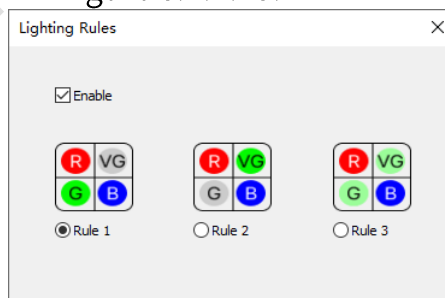

Fig 8.2.1.15 Lighting rules

Step 3: Set the calibration coefficients and click **Save** to check the display effect.

Calibration Coefficient Adjustment Area

Each “cell” in the coefficient adjustment area represents a single pixel.

- Click a pixel: Select the coefficient for that pixel.
- Double-click a pixel: Edit the coefficient for the selected pixel.
- Keyboard shortcuts
 - CTRL+A: Select all coefficients.
 - CTRL+C: Copy the real-time coefficients of the selected area.
 - CTRL+V: Paste the previously copied real-time coefficients.

8.2.2 By Cabinet

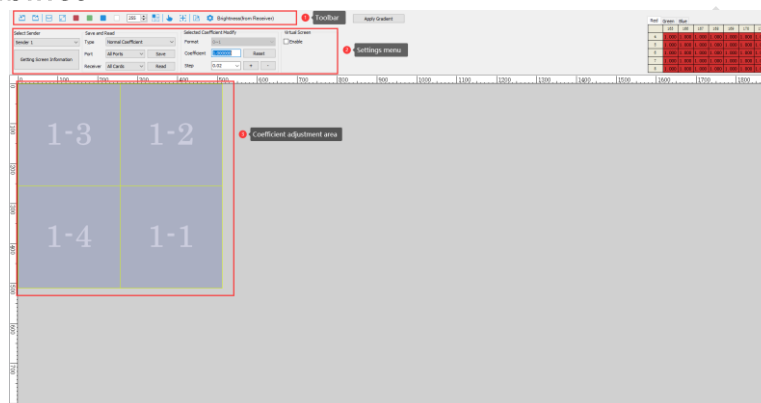

Fig 8.2.2.1 By Cabinet

Toolbar

The toolbar includes: **Import**, **Export**, **Show/Hide Screen**, **Screen Size**, 4 buttons for switching screen colors (Red, Green, Blue, White), **Grayscale adjustment**, **Rotation**, and **Calibration Settings**. For related functions, see Chapter 8.2.1 By Pixel.

: Click to open the **Module Size** dialog box, then enter the width and height.

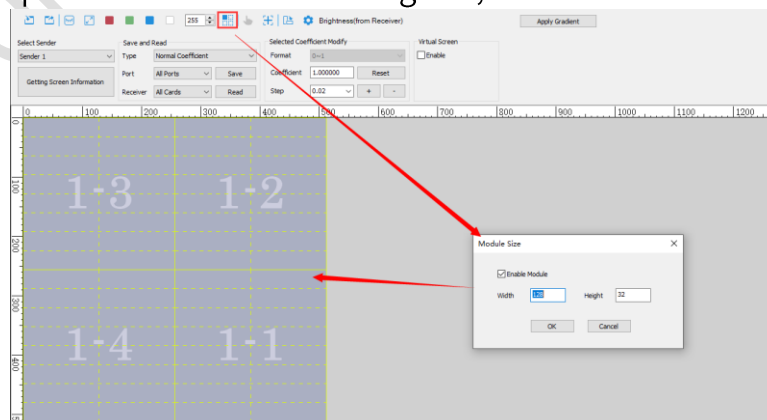



Fig 8.2.2.2 Set module size

: Click to select a receiver card. The selected receiver card will be displayed in highlight mode.

: Click this icon to display a cross cursor in the coefficient adjustment area. The values of the coefficients where you place the cross cursor will be shown in the top-right preview area.

Settings Menu

The functions are the same as the **By Pixel** settings menu. See Chapter 8.2.1 By Pixel for details.

- After making gradient adjustments to the coefficients in the selected area, click the **Apply Gradient** button. This will apply the adjusted gradient coefficients to the overall calibration coefficients.

Coefficient Adjustment Area

- If **Enable Module** is unselected:

Select the area for the receiver card, then right-click to display the menu.

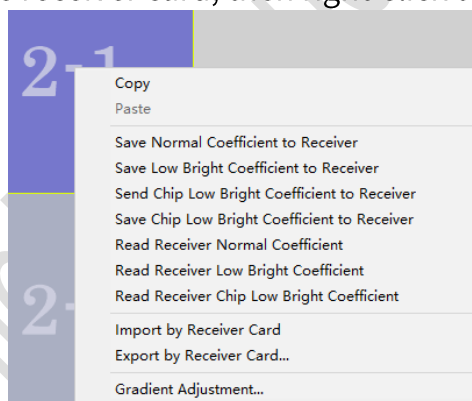

Fig 8.2.2.3 Receiver card right-click menu

The options under the context menu of the receiver card are described in Table 8.2.2-1.

Table 8.2.2-1 Description of receiver card context menu

Option	Description
Copy	Copy the real-time coefficients of the selected receiver card area.
Paste	Paste the copied real-time coefficients.
Save Normal Coefficient to	Save Normal Coefficient to the selected receiver card.

Receiver	
Save Low Bright Coefficient to Receiver	Save Low Bright Coefficient to the selected receiver card.
Send Chip Low Bright Coefficient to Receiver	Send Chip Low Bright Coefficient to the selected receiver card.
Save Chip Low Bright Coefficient to Receiver	Save Chip Low Bright Coefficient to the selected receiver card.
Read Receiver Normal Coefficient	Read normal coefficient of the selected receiver card.
Read Receiver Low Bright Coefficient	Read low bright coefficient of the selected receiver card.
Read Receiver Chip Low Bright Coefficient	Read chip low bright coefficient of the selected receiver card.
Import by Receiver Card	Import the coefficients to the selected receiver card area.
Export by Receiver Card	Export the coefficients from the selected receiver card area and save them to a local file.
Gradient Adjustment	Perform gradient adjustments on the coefficients of the selected receiver card area.

- If **Enable Module** is selected:

Select an area for the module, then right-click to display the menu.

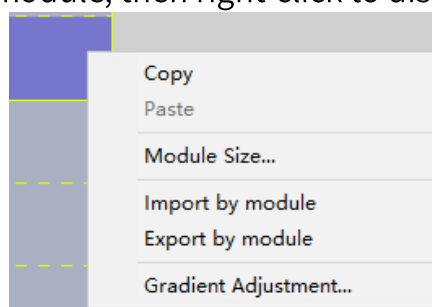

Fig 8.2.2.4 Module context menu

The options in the Module context menu are described in Table 8.2.2-2.

Table 8.2.2-2 Description of options in module context menu

Option	Description
--------	-------------

Copy	Copy the real-time coefficients of the selected receiver card area.
Paste	Paste the real-time coefficients of the copied area.
Module Size	Open the Module Size dialog box.
Import by Module	Import the coefficients to the selected module area.
Export by Module	Export the coefficients from the selected module area and save them to a local file.
Gradient Adjustment	Perform gradient adjustments on the coefficients of the selected module area.

8.2.3 By Module

Prerequisite: The receiver card program supports writing **Module UID**, and the receiver card parameters are configured correctly for the **intelligent modules**.

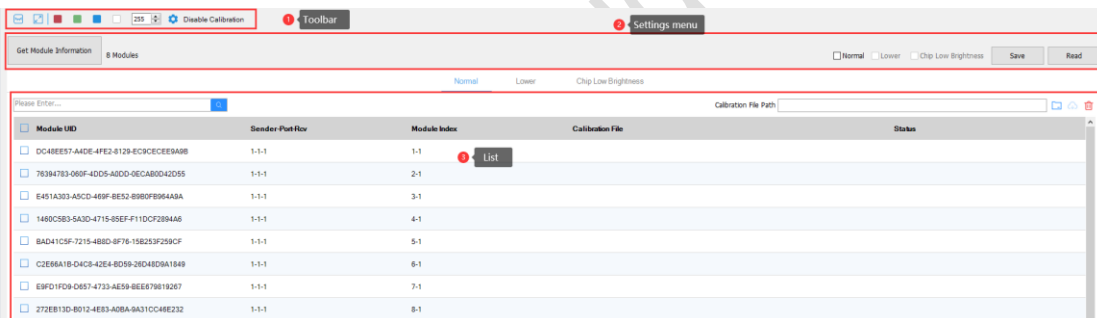

Fig 8.2.3.1 By Module

Toolbar

See Chapter 8.2.1 By Pixel for details.

Settings Menu

- **Get Module Information:** Click to get the screen and intelligent module information, which will then display as text to the right of the button.
- **Calibration coefficient types:** Support 3 types - **General**, **Lower**, and **Chip Low Brightness Calibration**.
- **Save:** After loading a local calibration coefficient file, click **Save** to save the calibration coefficients of a designated type to the selected module.
- **Read:** Read back the calibration coefficients of a designated type from

the selected module, and save them to a local folder.

List





- Tab switching: Switch between the 3 tab pages, namely, **General**, **Lower**, and **Chip Low Brightness Calibration**, to view the corresponding module information.
- Search: Enter the keyword in the search box. Click  to find all modules meeting the search criteria.
- Calibration file path: Display the path of the loaded calibration coefficient folder.
- : Click to select a local calibration coefficient folder that you want to load.
- : Click to download the calibration coefficient file from the server.
- : Delete the loaded correction coefficient file.
- List: Display the obtained module information, as shown in Table 8.2.3-1.

Table 8.2.3-1 Description of module information

List Field	Description
Module UID	Display module UID information.
Sender-Port-Rcv	Display the physical connection location of the modules.
Module index	Consistent with the module indexes as configured in Receiver Parameters – Intelligent Module Settings .
Calibration file	Match the calibration coefficient files from the loaded calibration folder based on the module UID information.
Status	Display calibration coefficients readback and saving status.

8.2.4 Deseam

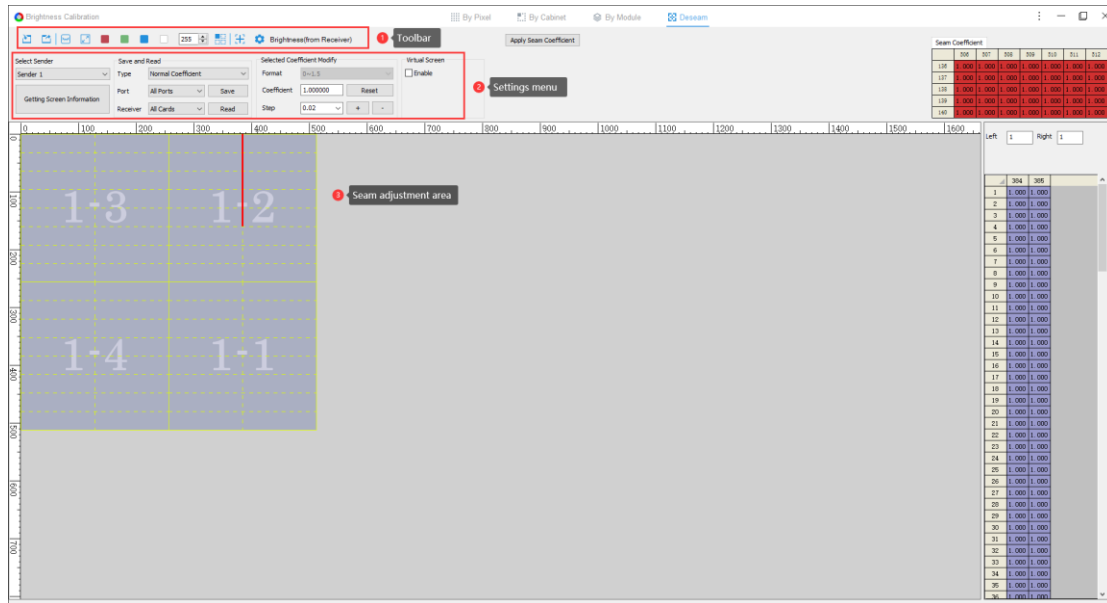

Fig 8.2.4.1 Brightness Calibration – Deseam

Toolbar

See Chapters 8.2.1 By Pixel and 8.2.2 By Cabinet for details.

Settings Menu

See Chapter 8.2.1 By Pixel for details.

- **Reset:** Reset the seam coefficients of all seams or selected seams.
- **Apply Seam Coefficient:** After adjusting the coefficients in the selected area, click the **Apply Seam Coefficient** button. This will apply the adjusted seam coefficients to the overall calibration coefficients.

Seam Adjustment Area

- **Seam Settings:** Select a seam to adjust its settings for range and coefficients.
- **Seam Range Settings:** The **Seam Setting** area is located to the right or below the coefficient adjustment area. Here, you can enter desired values for **Left/Right** to adjust the width of the seam range, and enter desired values for **Start/End** to adjust where the seam is positioned.

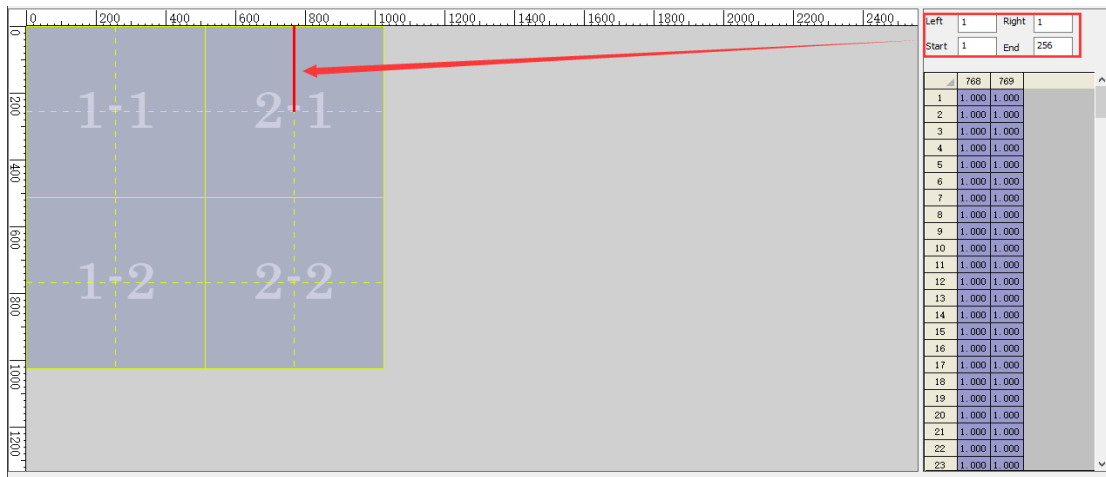

Fig 8.2.4.2 Seam range settings

- **Seam Coefficient Settings:** In the **Selected Coefficient Modify** area, you can enter values in the **Coefficient** input field to adjust the seam coefficient settings.

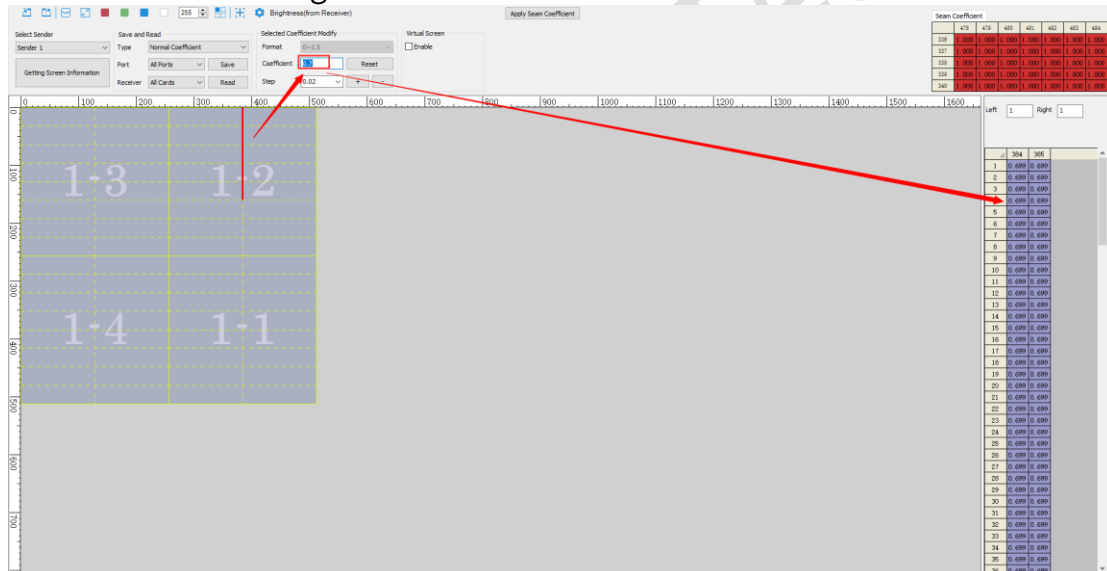

Fig 8.2.4.3 Seam coefficient settings

- **Context Menu:** Select a seam and right-click to display the context menu.

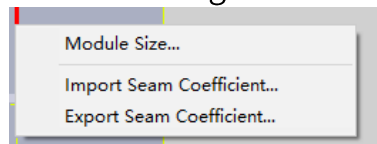

Fig 8.2.4.4 Seam context menu

The options under the context menu of the Seams are described in Table 8.2.4-1.

Table 8.2.4-1 Description of seam context menu

Option	Description
Module Size	Open the Module Size dialog box.
Import Seam Coefficient	Import seam coefficients to the position where the selected seam is located.
Export Seam Coefficient	Export seam coefficients to a local file.

 Notes:

- When exporting seam coefficients, the corresponding seam positions will be automatically saved with the coefficients.
 - When importing seam coefficients, you need to manually enter the seam positions to match the correct locations.
-

8.3 Chroma Calibration

Chroma Calibration is based on the fundamental principle of chroma compensation, which involves compensating for each primary color by two additional primary colors and adjusting the colors through mixing. Chroma Calibration consists of 9 components: Rr, Rg, Rb, Gr, Gg, Gb, Br, Bg, and Bb.

This chapter only introduces the functions of **Color Gamut Adjustment** and **Batch Adjustment**. For the remaining functions, see Chapter 8.2 Brightness Calibration.

- Color Gamut Adjustment
 - : Go to the **By Pixel** tab and click this button to open the **Color Gamut Adjustment** dialog box.
- Step 1: Open the **Original Value** tab to obtain the color gamut of the current screen.

As shown in Fig 8.3.1, there are 4 ways to obtain the color gamut of the receiver card:

- Edit the input values in the table.
- Click the **Measured by Colorimeter** option.
- Import color gamut data.
- Read back data directly from the receiver card.

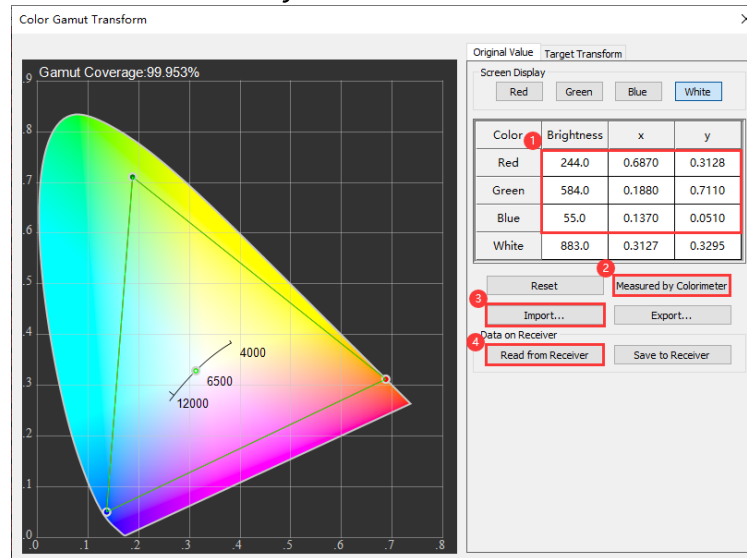

Fig 8.3.1 Obtain original color gamut

 **Note:**

If the display is already calibrated, first read back the existing calibration coefficients before adjusting the color gamut. Then, determine whether calibration needs to be performed again based on your specific needs. After that, you can proceed with adjusting the color gamut.

■ **Step 2: Select the Target Transform tab to set the target color gamut.**

As shown in Fig 8.3.2, there are 3 ways to set the target gamut:

- Choose a target color gamut option.
- Edit the input values in the table.
- Import a target color gamut.

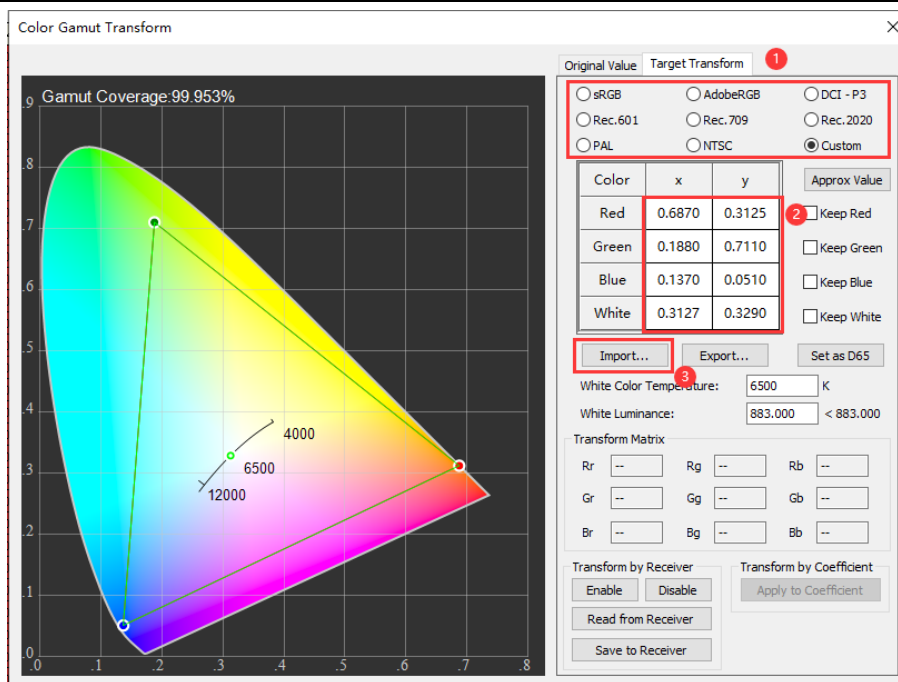

Fig 8.3.2 Set target color gamut

- Step 3: Click **Approx Value** and select the checkboxes for **Keep Red**, **Keep Green**, **Keep Blue**, **Keep White**, or **Set as D65** based on your actual requirements. This will automatically generate a transform matrix, as shown in Figure 8.3.3.

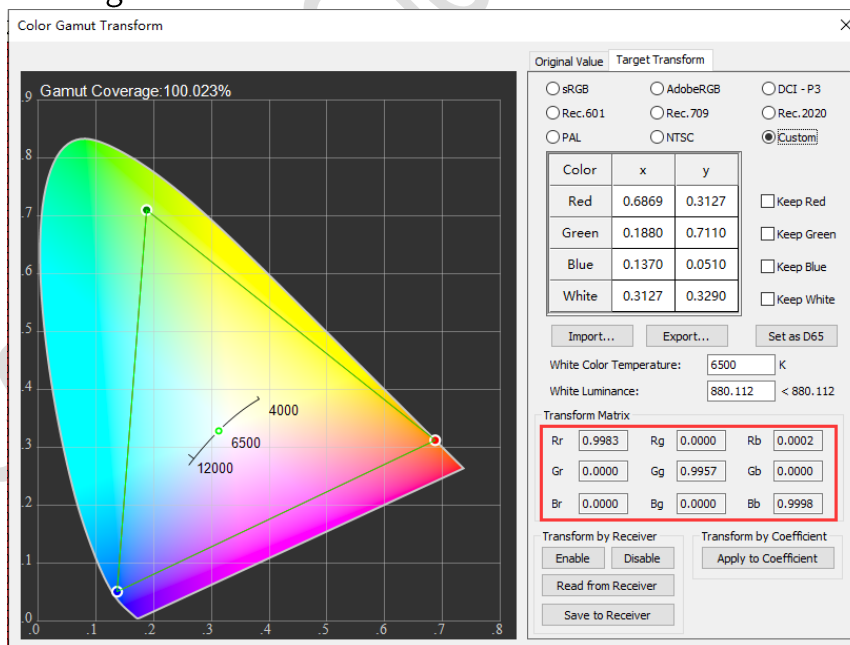

Fig 8.3.3 Generate transform matrix

- Step 4: Select a desired mode between **Transform by Receiver** and **Transform by Coefficient**.

◆ **Transform by Receiver:**

- Click **Enable** to turn on Transform by Receiver.
- Click **Save to Receiver** to complete the color gamut adjustment for the receiver card.
- Check the screen to see the effect after adjusting the color gamut, as shown in Figure 8.3.4.

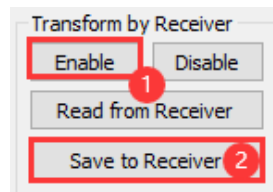

Fig 8.3.4 Transform by receiver

◆ **Transform by Coefficient:**

- Click **Apply to Coefficient** to turn on Transform by Coefficient.
- Enable **Chroma** and click **Save Calibration Coefficient** to save the adjusted coefficient.
- Check the screen to see the effect after adjusting the color gamut.

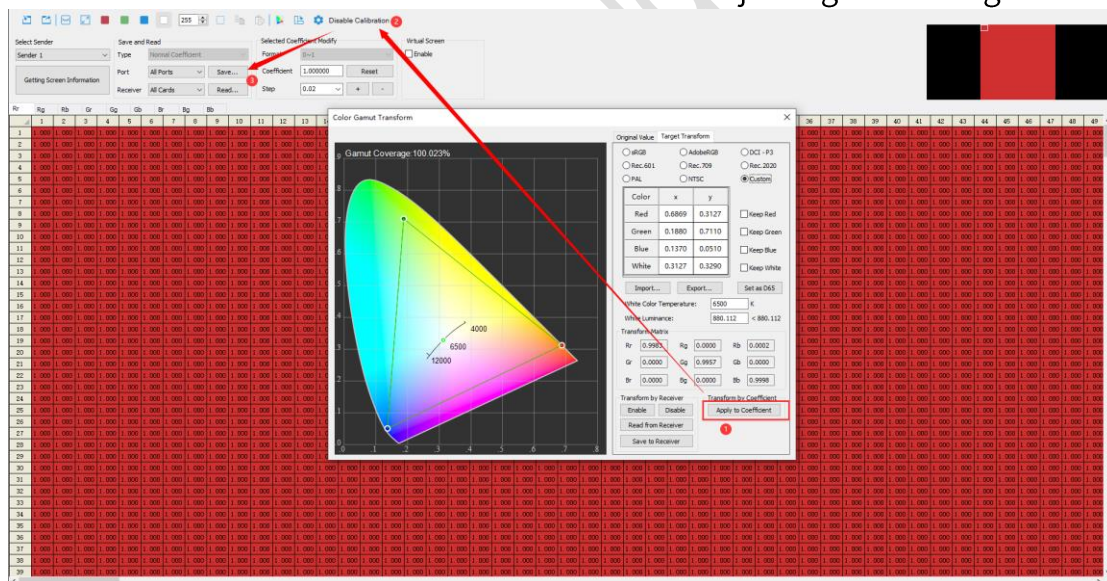

Fig 8.3.5 Transform by coefficient

● **Batch Adjustment**

➡: Go to the **By Cabinet** tab and click this button to open the drop-down menu. Batch adjustments can be made in **Settings**.

■ **Step 1:** Click ➡ and select **Settings** to open the **Batch Adjustment Settings** dialog box. Under **Adjust Mode**, choose either **Adjust by Origin Coordinate** or **Adjust by Coefficient**. Add a batch by typing in the table

values directly or clicking **Import Batch** under **Batch Information**, as shown in Figure 8.3.6.

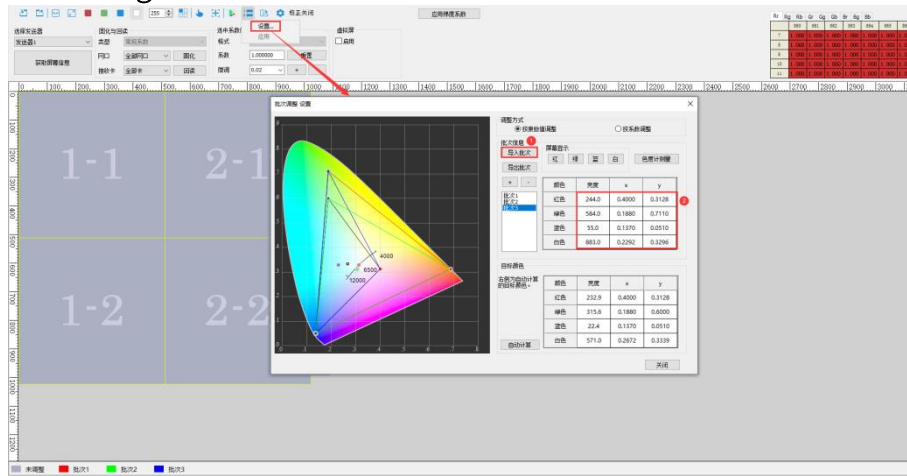

Fig 8.3.6 Set batch information

Note:

If the display is already calibrated, first read back the existing calibration coefficients before making batch adjustments. Then, determine whether calibration needs to be performed again based on your specific needs. After that, you can proceed with making batch adjustments.

- **Step 2:** Close the **Batch Adjustment Settings** dialog box. Then, select a receiver card, right-click and select **Batch designation** to perform batch designation on the selected card, as shown in Figure 8.3.7.

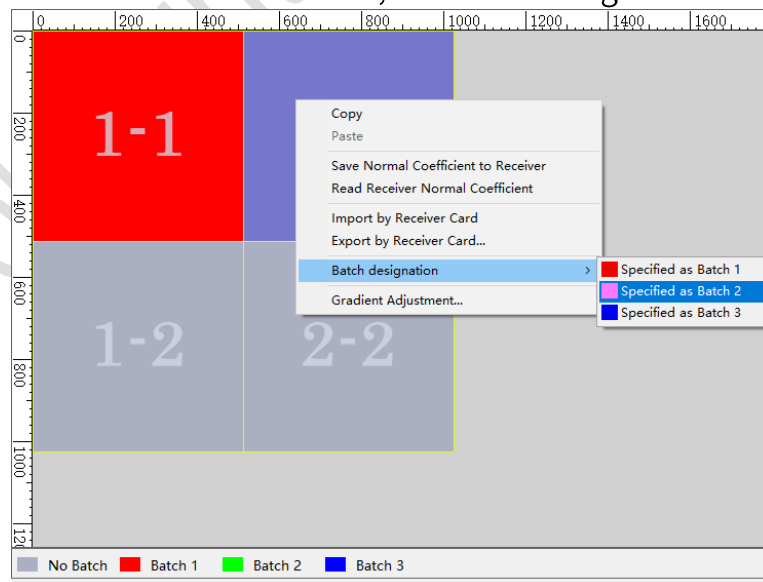



Fig 8.3.7 Batch designation

- **Step 3:** Click  and select **Apply** to apply the batch adjustment to the

specified calibration coefficients, as shown in Figure 8.3.8.

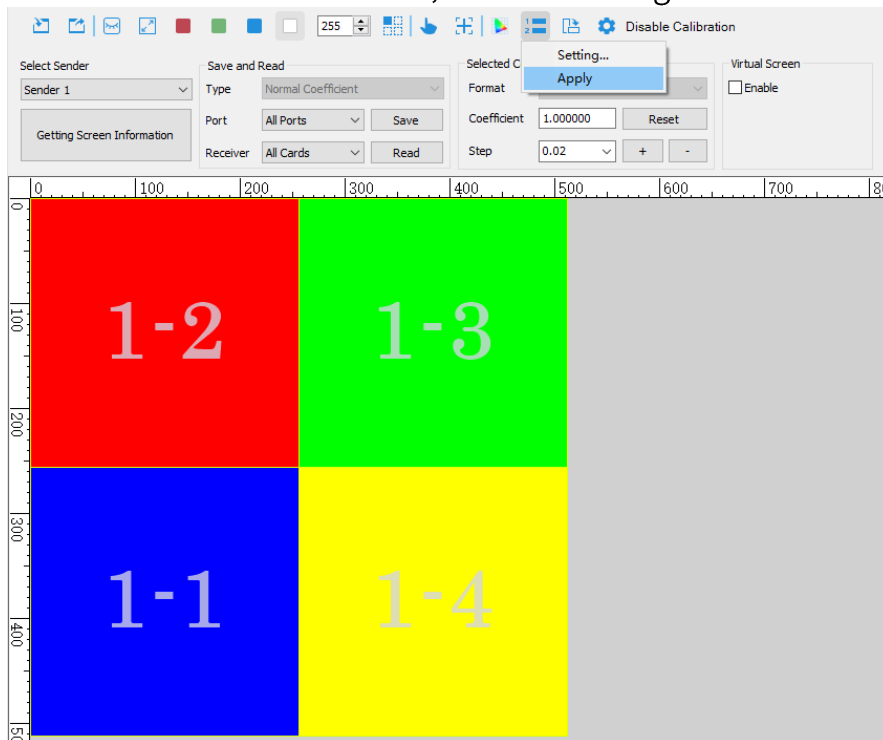

Fig 8.3.8 Apply batch adjustment

- Step 4: Enable **Chroma** and click **Save Calibration Coefficient** to save the adjusted coefficient. Check the screen to see the effect after adjusting the color gamut.

8.4 Special Calibration

8.4.1 Double Calibration

- **Brightness**

Step 1: Go to **Receiver Parameters > Calibration** to enable **Low Grayscale** and **High Grayscale** under **Double Calibration**. Specify the threshold values under **Brightness Threshold Adjustment**. Then click **Save to Receivers**, as shown in Figure 8.4.1.1.

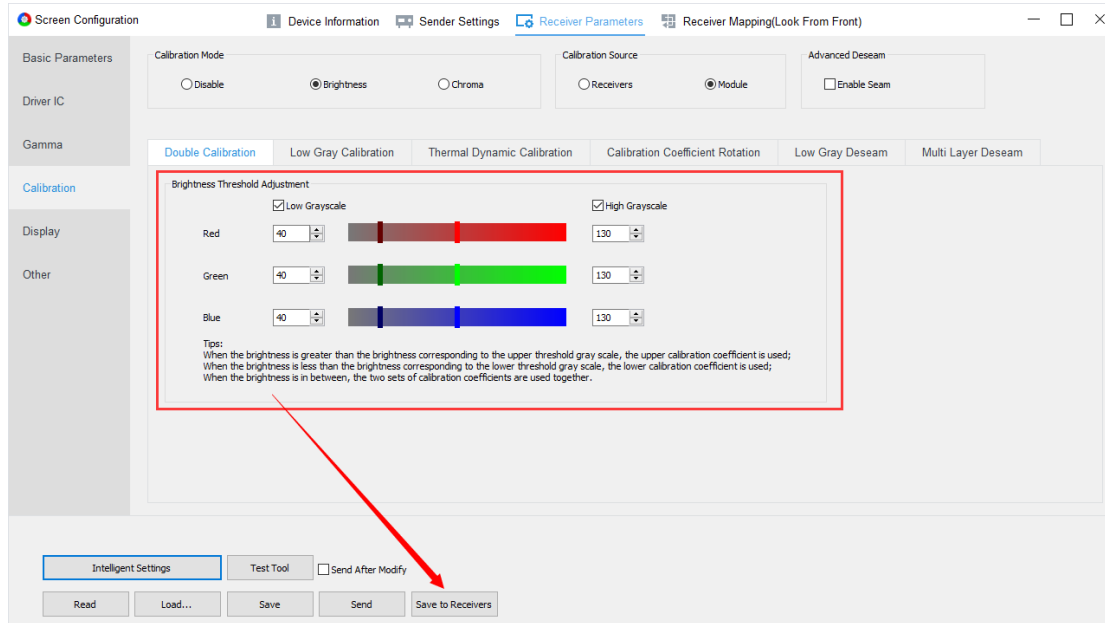

Fig 8.4.1.1 Brightness – Enable double calibration

Step 2: Go to **Pixel-by-pixel Calibration > Brightness**, and click **Getting Screen Information**.

To set the high layer coefficient:

- Select the **Normal Coefficient** type.
- Click **Save** to apply the high layer coefficient.

To set the low layer coefficient:

- Select the **Low Level Coefficient** type.
- Click **Save** to apply the low layer coefficient.

As shown in Fig 8.4.1.2.

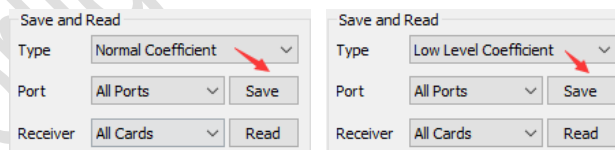

Fig 8.4.1.2 Save high/low level coefficients

Step 3: Adjust the grayscale range for corresponding threshold values and check the display effect.

■ Chroma

After enabling **Double Calibration**, you can choose **High Priority** or **Low Priority** under **Chroma**. This affects how the display shows colors based on the image components:

- ◆ For main components (Rr, Gg, and Bb): The display matches the

threshold settings you configured.

- ◆ For minor components (Rg, Rb, Gr, Gb, Br, and Bg):

If you select **Low Priority**: The minor components use only the lower calibration coefficients.

If you select **High Priority**: The minor components use only the upper calibration coefficients.

8.4.2 Low Gray Compensation Calibration

Step 1: Click **Getting Screen Information**. To set the calibration coefficients, select **Low Brightness Coefficient** as the type, then click **Save**, as shown in Figure 8.4.2.1.

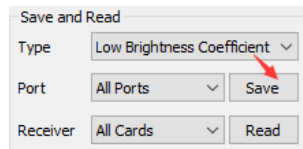

Fig 8.4.2.1 Save low brightness coefficient

Step 2: Click and select **Set Calibration Switch** to open the **Calibration Settings** dialog box. Select the checkbox for **Enable Low Gray Calibration**, as shown in Figure 8.4.2.2.

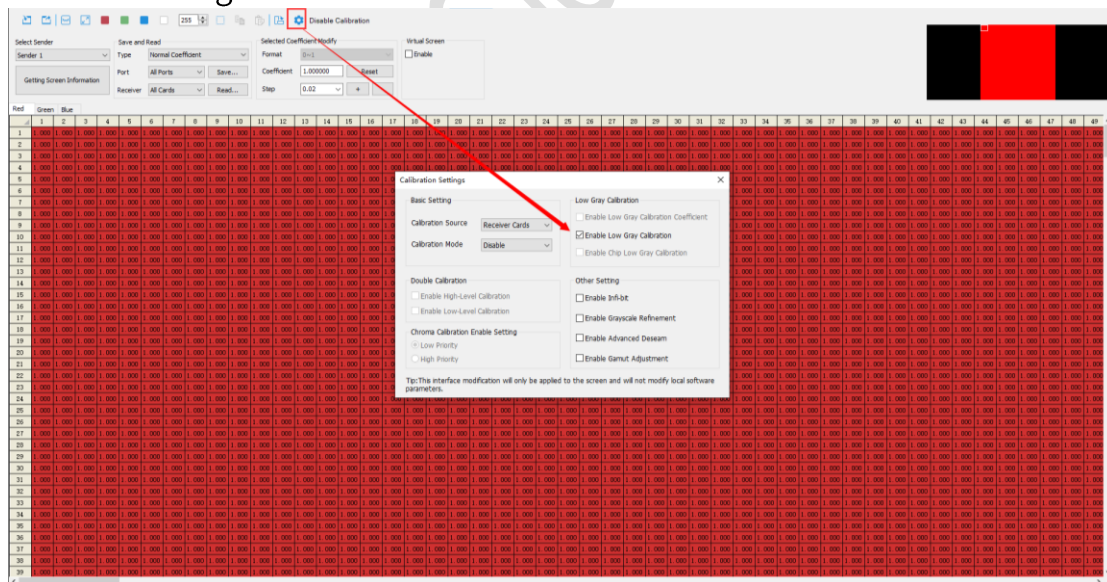

Fig 8.4.2.2 Enable low gray calibration

Step 3: View the effect of **Low Gray Compensation Calibration** on the screen in the low grayscale mode.

8.4.3 Chip Low Brightness Calibration

Step 1: Click Getting Screen Information. To set the calibration coefficient, select **Chip Low Brightness Coefficient** as the type, then click **Save**, as shown in Figure 8.4.3.1.

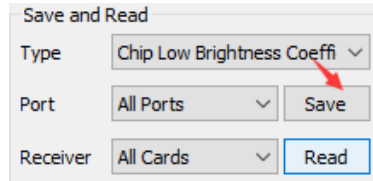



Fig 8.4.3.1 Save chip low brightness coefficient

Step 2: Click  and select **Set Calibration Switch** to open the **Calibration Settings** dialog box. Select the checkbox for **Enable Chip Low Gray Calibration**, as shown in Figure 8.4.3.2.

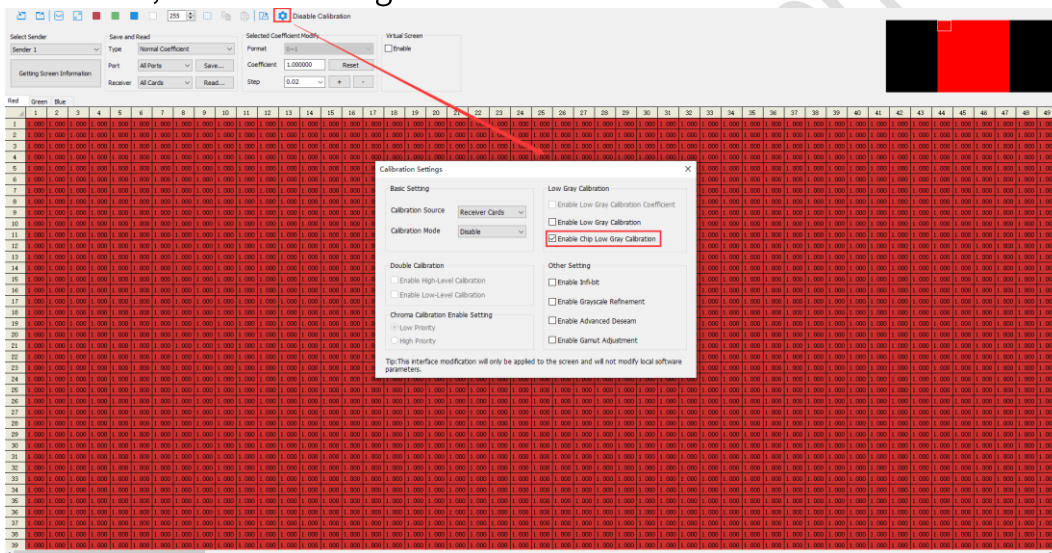

Fig 8.4.3.2 Enable chip low gray calibration

Step 3: View the effect of the **Chip Low Brightness Calibration** at low grayscales on the screen.

8.4.4 Coefficient Backup

Coefficient Backup allows you to save a copy of the calibration coefficients in the backup area of the receiver card.

If the coefficients in the application area of the receiver card get changed, you can click **Restore Backup** to restore the coefficients from the backup area back to the application area. This will restore the calibration effect.

■ Enable Coefficient Backup

Enter “dkbf” under **Basic Parameters** and press **Enter** to enable the coefficient backup function in **Brightness Calibration**, as shown in Figure 8.4.4.1.

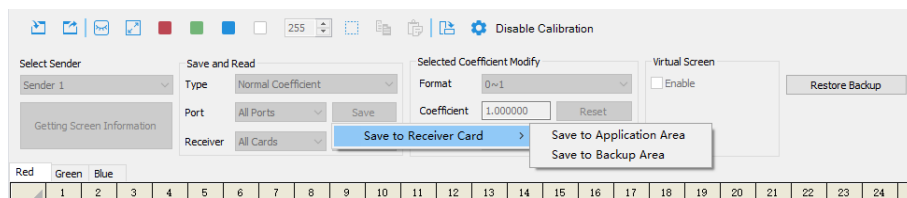

Fig 8.4.4.1 Enable coefficient backup

📖 Note:

For a receiver card program that supports coefficient backup, a **Restore Backup** button will appear under **Calibration Settings**.

8.4.5 Sender Cascading Calibration

Step 1: Double-click on **Brightness/Chroma** under **Pixel-by-pixel Calibration** in the main interface to set parameters under **Senders Offset Setting**. Then, click **OK** to access the **Brightness/Chroma Calibration** interface, as shown in Figure 8.4.5.1.

(Note: Normally, no offset adjustment is required. Only if the physically connected LED display has an offset do you need to adjust the offset value to match your particular setup.)

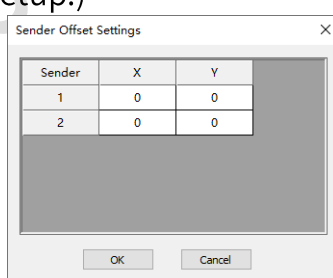



Fig 8.4.5.1 Senders offset setting

Step 2: Click **Getting Screen Information**. Then click  to set the size and coordinates of the calibration canvas according to the actual screen.

Step 3: Select the desired options under **Type** and **Format** for calibration coefficients.

Step 4: Import the calibration coefficients, or set the calibration coefficients

in the coefficient adjustment area.

Step 5: Click  and select **Set Calibration Switch** to open the **Calibration Settings** dialog box. Then, select the desired options under **Calibration Source** and **Calibration Mode**.

Step 6: Switch between each sender and save its calibration coefficients to the corresponding receiver card. Then, check the display effect on the corresponding LED screen, as shown in Figure 8.4.5.2.

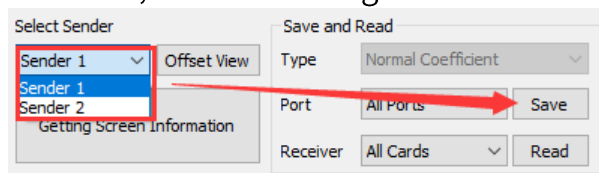

Fig 8.4.5.2 Save calibration coefficients for different senders

9. Multi-function Card

The iM9 Multi-function Card is an important accessory of the Colorlight control system for environmental monitoring and remote control. iM9 can monitor the operating environment of the LED displays in real time. This chapter introduces version 2.0 of the iM9.

9.1 Sensor Information

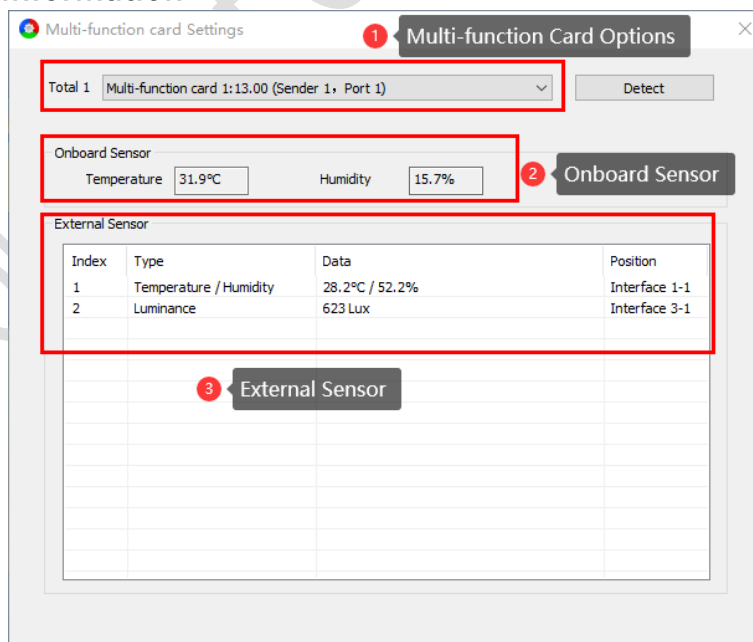

Fig 9.1.1 Sensor information

Multi-function Card Options

- Quantity: Display the total number of connected multi-function cards.
- Dropdown menu: Switch between the dropdown options, with the interface displaying the corresponding sensor information for the selected multi-function card.
- Detect: Click to detect multi-function cards and refresh the interface.

Onboard Sensor

The multi-function card contains built-in onboard sensors that measure temperature and humidity. The software automatically reads data from these sensors.

External Sensor

The description for items under **External Sensor** is shown in Table 9.1-1.

Table 9.1-1 Description of items under external sensor

Item	Description
Index	Display the external sensor index.
Type	Display the sensor type. The supported sensors include brightness sensors, temperature and humidity sensors, noise sensors, smoke sensors, and air quality sensors.
Data	Display the environmental information detected by the external sensors.
Position	Display the physical interface positions for the external sensors on the multi-function card.

9.2 Relay Control

Multi-function Card Time

This feature is used for the timing control function of Relays J9~J12 on the multi-function card.

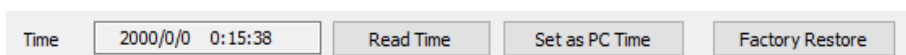

Fig 9.2.1 Multi-function card time

- **Time:** Show the internal clock from the selected multi-function card.
- **Read Time:** Read the current time from the selected multi-function card and update with the latest time.

- **Set as PC Time:** Sync the selected multi-function card with the local PC time.

Factory Restore

Click **Factory Restore** to clear the commands that have been set for the multi-function card.

Screen Power

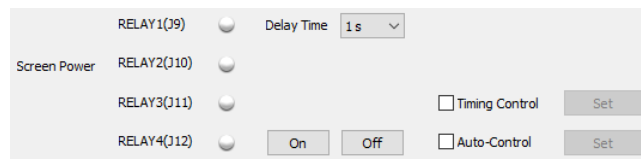

Fig 9.2.2 Screen power

- Click the **On/Off** button to turn on/off **Screen Power** manually. Select an option from **Delay Time** to change the time intervals for manually closing/opening J9~J12.
- **Timing Control:** Enable **Timing Control** to set **Timing Command**.
- **Timing control Command:** Relays J9~J12 will execute the command at the time specified in **Timing Command**.

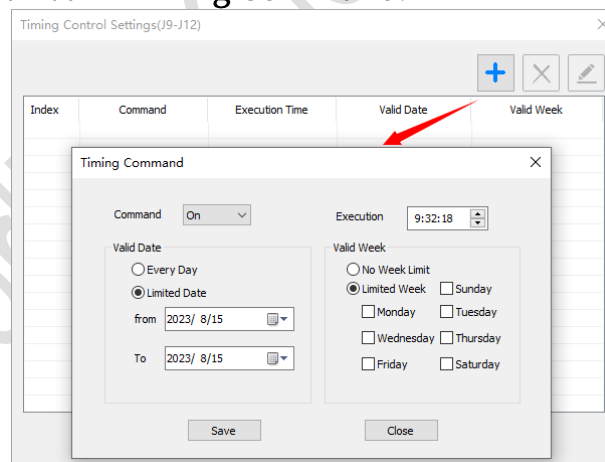

Fig 9.2.3 Set timing command

- **Auto-Control:** Enable **Auto-Control** to set an automatic control demand.

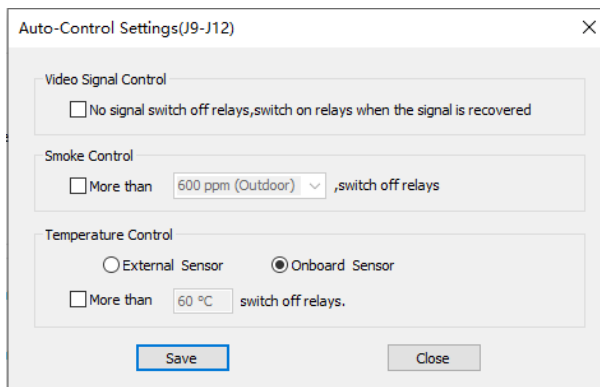

Fig 9.2.4 Auto-control settings (J9-J12)

J13-J16

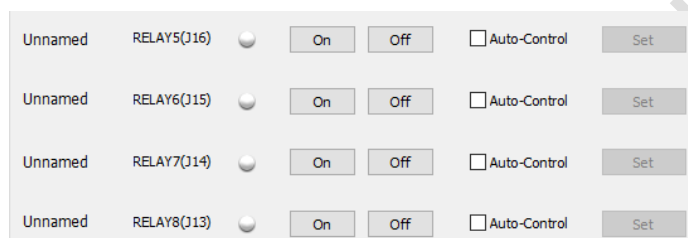

Fig 9.2.5 J13~J16

- Click the **On/Off** button to control the relay to turn on/off.
- **Auto-Control:** Enable **Auto-Control** to set an auto-control command for the designated relay.

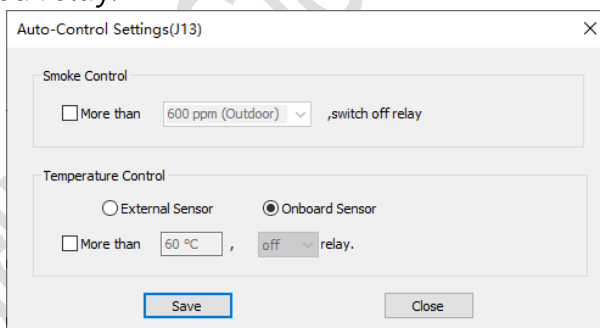

Fig 9.2.6 Auto-control settings

9.3 Auto Brightness Adjust

Auto Brightness Adjust

Select the checkbox for **Enable Automatic Adjustment** to enable auto brightness adjustment. When environmental illumination cannot be collected, the display brightness will be adjusted to the level set under **Cannot Collect Illumination, Set The Brightness To:**.

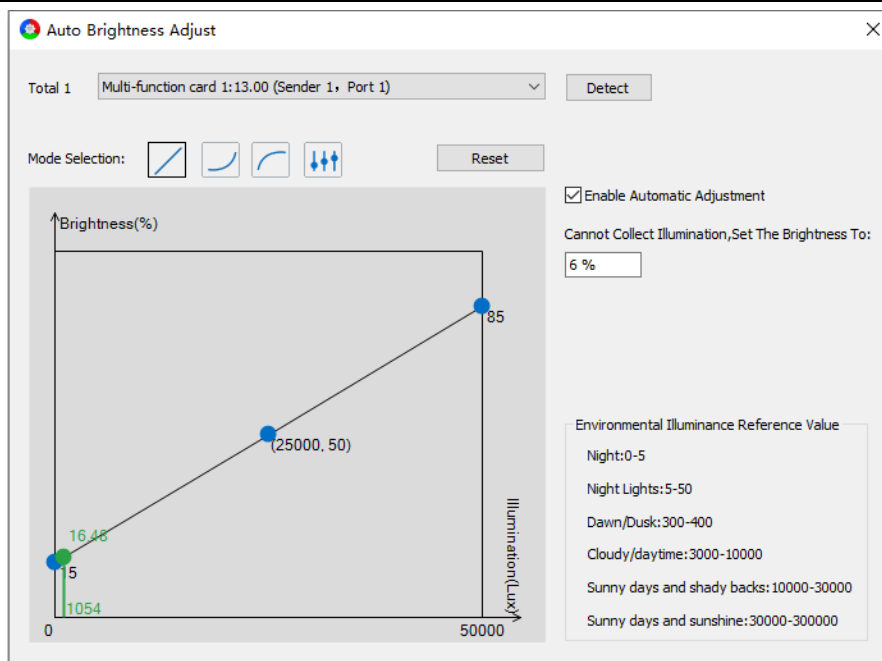



Fig 9.3.1 Enable automatic adjustment

Mode Selection

- **Mode Selection:** Click one of the 4 mode icons  to apply corresponding brightness adjustment curve: Linear, Gamma, Anti Gamma, and Custom.
- **Reset:** Click to reset the curve under the corresponding mode.
- **Curve Adjustment Panel:** The horizontal axis represents **Illumination** levels, while the vertical axis represents **Brightness** levels. You can drag the blue dot points on the curve to modify the automatic brightness adjustment curve.

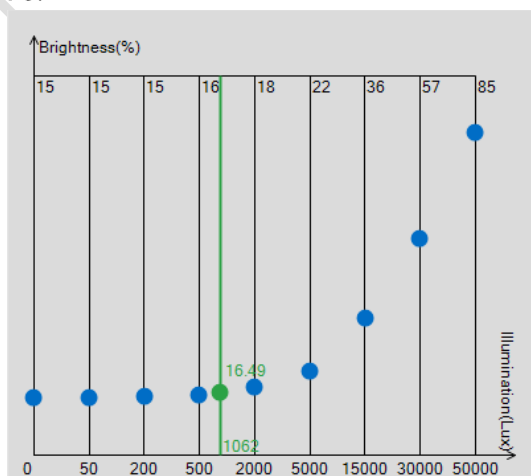

Fig 9.3.2 Curve adjustment panel

- Blue curve: Edit the shape of the **Illumination – Brightness** curve.
- Green line: Show the detected illumination level and the corresponding brightness level of the sender on the automatic adjustment curve.

9.4 Troubleshooting

- Issue 1: After commands are sent from the controller or serial port, the commands are not executed.

1. Use a serial debugging assistant (for example, UartAssist) to check and configure the serial port settings:

- Select a COM number from the **PortNum** drop-down menu.
- Configure the serial port parameters, as shown in Figure 9.4.1.

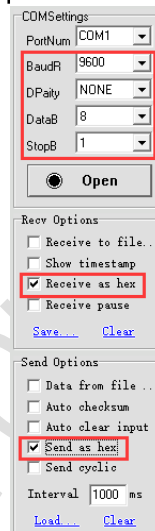

Fig 9.4.1 Set serial port parameters

2. To check if the serial port driver is installed:

- Go to **This PC > Manage > Device Manager > Ports (COM & LPT)**;
- Confirm that the serial port listed under **Ports** corresponds to the port selected in the serial debugging assistant, as shown in Figure 9.4.2.



Fig 9.4.2 Serial port number identification

3. Disable Auto-control command on the multi-function card;
4. If commands are issued via the serial port and a correct return value is

received but the command is not executed, there are 2 possibilities to check:

- The same command is being sent repeatedly.
 - The relay is damaged.
5. Manually turn the relay on/off to check if the relay is functioning properly.
 6. Ensure the serial port cable is within the 10 meters limit.
 7. Adopt the correct wiring method if an adapter cable is used.
-
- Issue 2: The screen brightness level does not change automatically after configuring the **Auto Brightness Adjust** setting.
 1. Check if the **Auto Brightness Adjust** curve on the multi-function card is configured correctly.
 2. Check the sensor information on the multi-function card to determine:
 - If the brightness sensor can be detected correctly.
 - If illumination levels can be measured accurately.
 3. Confirm that the multi-function card is connected to Port1 on Sender1.

 - Issue 3: Relays J9~J12 are not responding as expected to control signals from the host computer.
 1. Check the multi-function card and verify if it can communicate properly with the sender.
 2. Check the video source interface of the sender and modify parameters under the icon  if necessary.
 3. Manually turn the relay on/off to check if the relay is functioning properly.

 - Issue 4: The preprogrammed timing controls on the multi-function card are not functioning.
 1. Confirm that the internal clock is working properly by reading the date and time from the multi-function card multiple times.
 2. Confirm that the **Timing Command** have been successfully saved to the multi-function card.
 3. Manually turn the relay on/off to check if the relay is functioning properly.

10. Monitor

The Monitor interface is comprised of 4 key components: Setting, log, toolbar, and information preview area. Its primary function is to monitor connected devices and ensure they are operating normally. The interface constantly monitors device activity, and if any abnormalities are detected, the user is immediately notified via email. This feature helps prevent adverse consequences that may result from device malfunctions.

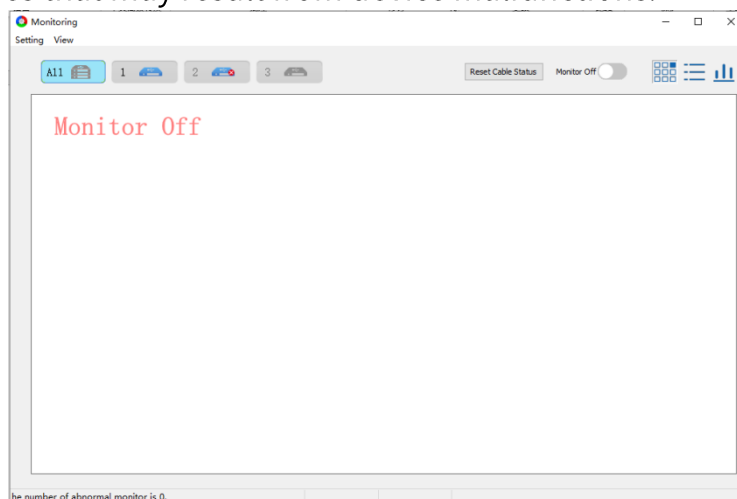

Fig 10.1 Monitor interface

Step 1: Navigate to the **Monitoring** interface to turn Monitor on. Then confirm that all devices are connected well.

Step 2: Click the **Setting** button to open the **Monitor Setting** dialog box. Configure the settings for **Monitor Item**, **Param Range** and **Email**, as shown in Figure 10.2.

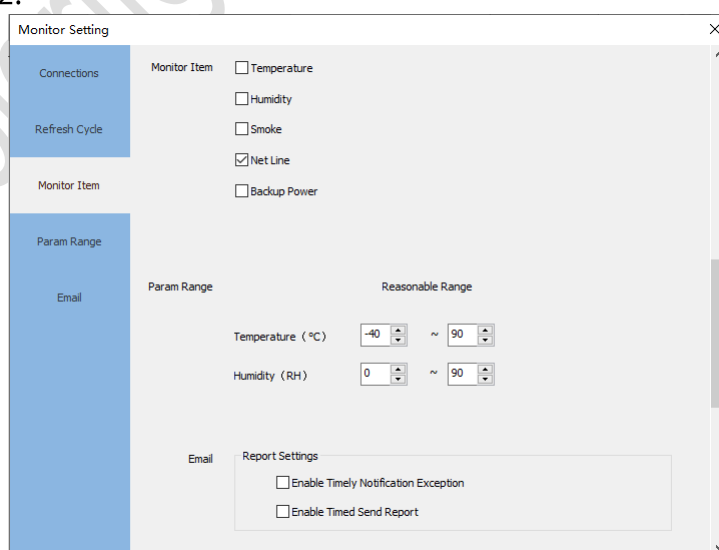

Fig 10.2 Set monitor item



Step 3: Navigate back to the main interface of **Monitoring** to access and view the monitoring information of the connected devices.

10.1 Toolbar

The toolbar includes a sender selection area, **Reset Cable Status** button, Monitor on/off switch, and 3 icons for preview modes.



Fig 10.1.1 Monitor configuration

- Sender selection area: Display all cascaded senders. Select a sender to view its monitoring information. If a sender is not connected, the  icon will be displayed. If a sender has no signal, the  icon will be displayed.
- Reset Cable Status: Click this button to reset the network packets and error packets for the receiver under the selected sender.
- Monitor Off (Default): Click  to turn on Monitor.
- 3 preview modes available: Graphics, List, and Briefing.

10.2 Monitor Preview Area

The preview area displays the information of every connected device. If any device issues are detected, a status banner will scroll at the bottom of the preview area, showing the total number of monitors as well as the number of abnormal monitors.

- Graphics mode: Display the mapping diagram of the receivers, showing the cascading order of senders from top to bottom in the preview area.

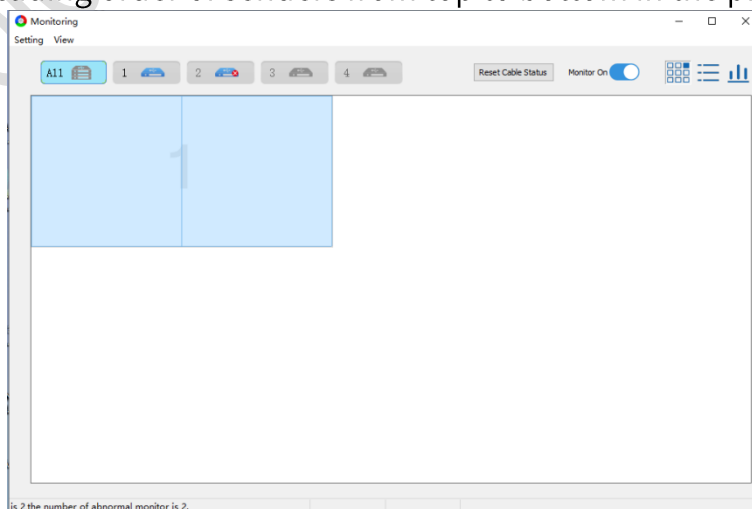
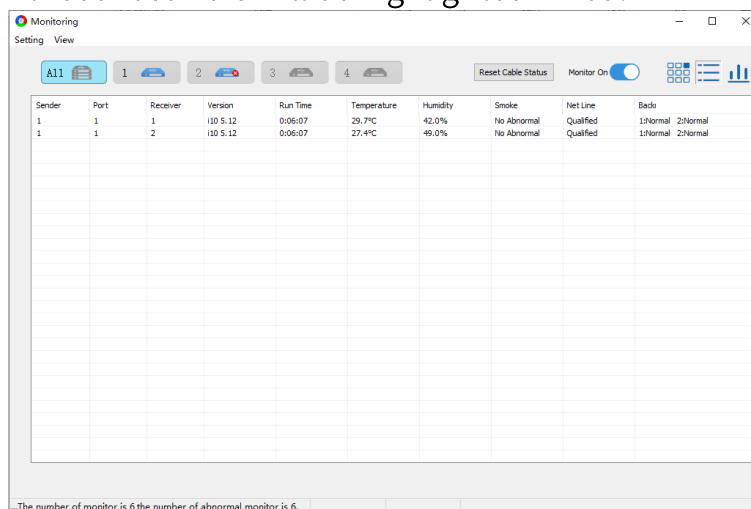

Fig 10.2.1 Graphics mode

- List mode: Display the receiver information in a list organized by the cascading order of their corresponding senders and network port numbers. When abnormalities are monitored, the corresponding list items for those receivers will be highlighted in red.



Sender	Part	Receiver	Version	Run Time	Temperature	Humidity	Smoke	Net Line	Back
1	1	1	10 S.12	0:06:07	29.7°C	42.0%	No Abnormal	Qualified	1:Normal 2:Normal
1	1	2	10 S.12	0:06:07	27.4°C	49.0%	No Abnormal	Qualified	1:Normal 2:Normal

...The number of monitor is 6,the number of abnormal monitor is 6.

Fig 10.2.2 List mode

- Briefing mode: Display port information in a briefing format organized by the cascading order of their corresponding senders.

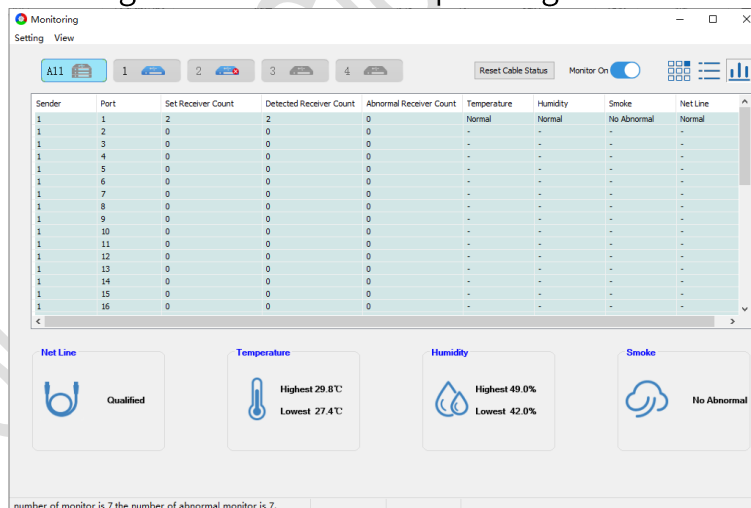

Sender	Port	Set Receiver Count	Detected Receiver Count	Abnormal Receiver Count	Temperature	Humidity	Smoke	Net Line
1	1	2	2	0	Normal	Normal	No Abnormal	Normal
1	2	0	0	0	-	-	-	-
1	3	0	0	0	-	-	-	-
1	4	0	0	0	-	-	-	-
1	5	0	0	0	-	-	-	-
1	6	0	0	0	-	-	-	-
1	7	0	0	0	-	-	-	-
1	8	0	0	0	-	-	-	-
1	9	0	0	0	-	-	-	-
1	10	0	0	0	-	-	-	-
1	11	0	0	0	-	-	-	-
1	12	0	0	0	-	-	-	-
1	13	0	0	0	-	-	-	-
1	14	0	0	0	-	-	-	-
1	15	0	0	0	-	-	-	-
1	16	0	0	0	-	-	-	-

Net Line



Qualified

Temperature



Highest 29.8°C
Lowest 27.4°C

Humidity



Highest 49.0%
Lowest 42.0%

Smoke



No Abnormal

number of monitor is 7,the number of abnormal monitor is 7.

Fig 10.2.3 Briefing mode

10.3 Monitor Setting

It allows configuration of **Connections**, **Refresh Cycle**, **Monitor Item**, **Param Range**, and **Email**.

Connections

It supports setting the number of cascaded senders and viewing the number of receivers connected to each sender.

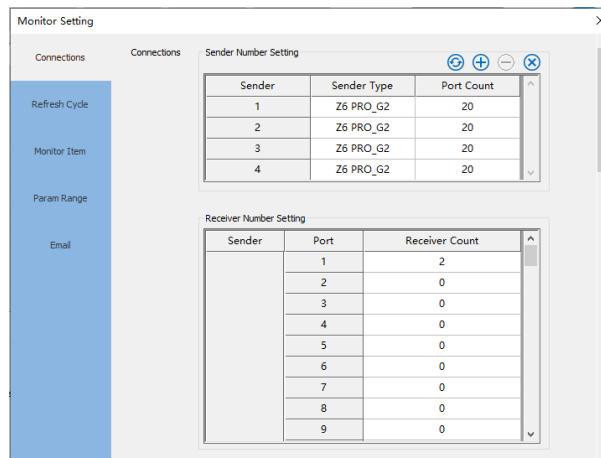



Fig 10.3.1 Connections

- : Click this icon to refresh the **Connections** interface.
- : Click this icon to open the **Sender Connection Settings** dialog box, and set the type and number of the sender.

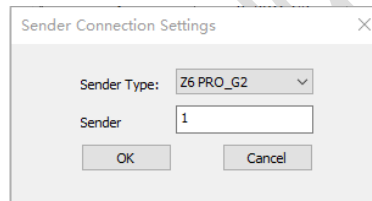



Fig 10.3.2 Sender connection settings

- : Click this icon to delete the selected sender.
- : Click this icon to delete all senders.

Refresh Cycle

Set the time for the software to automatically detect **Monitor** information.

Monitor Item

To monitor **Temperature**, **Humidity**, **Smoke**, **Net Line**, and **Backup Power**, select the corresponding checkboxes. This will enable monitoring for the selected items.

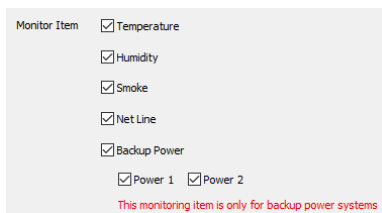

Fig 10.3.3 Monitor item

Param Range

Specify the range for monitoring temperature and humidity.

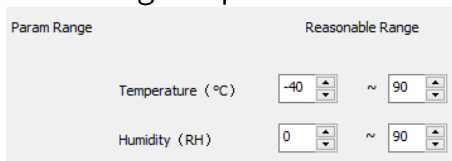

Fig 10.3.4 Param range

Email

Monitoring results can be notified to users via email, reminding users to follow up in time. This allows users to choose between 2 notification modes: **Enable Timely Notification Exception** and **Enable Timed Send Report**.

- **Enable Timely Notification Exception:** Select this option to receive an email notification if any monitored items exceed their exception thresholds.
- **Enable Timed Send Report:** Select this option to receive regular monitoring reports by email on a scheduled basis.
- **Sender Information:** Set the Sender's email information.

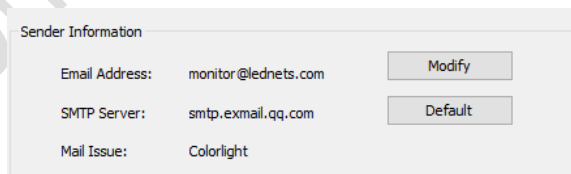

Fig 10.3.5 Sender information

- **Receiving Party Information:** Enter the user's email address.

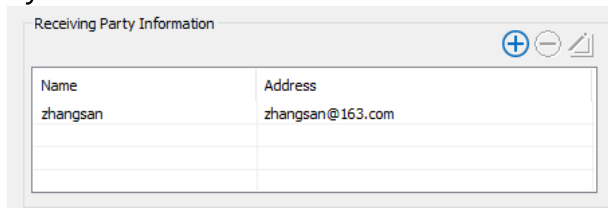

Fig 10.3.6 Receiving party information

- **Send Test Email:** Click this button to send a test email to the receiving party's inbox.

10.4 View History Exceptions and Email Log

Click **View** and then select **View History Exceptions**. This will display the abnormal information of the device recorded after enabling Monitor.

Receiver

This function allows you to view the exceptions monitored by the receiver during a specified time period.

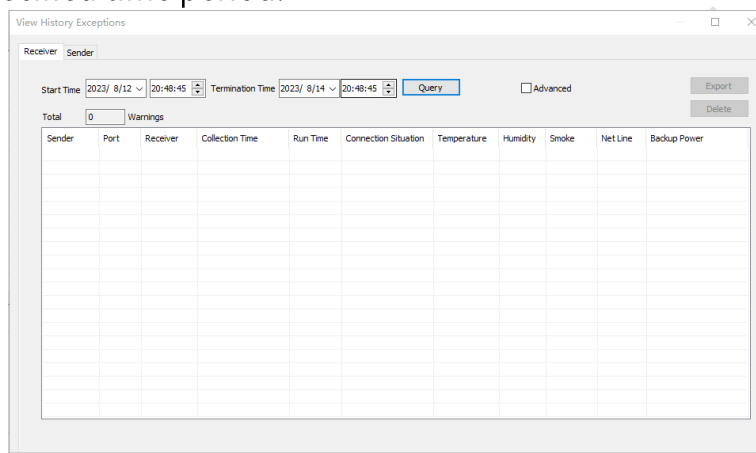

Fig 10.4.1 Exceptions from the receiver

- **Query:** Set **Start Time** and **Termination Time**, click **Query** to view abnormal information of the receiver within this time period.
- **Advanced:** Select the checkbox for **Advanced** to specify the port the sender should use for queries.
- **Export:** Click the button to export the information in the table and save it to a local file.
- **Delete:** Click the button to delete all contents in the table.

Sender

This function allows you to view the exceptions monitored by the sender between selected dates/times.

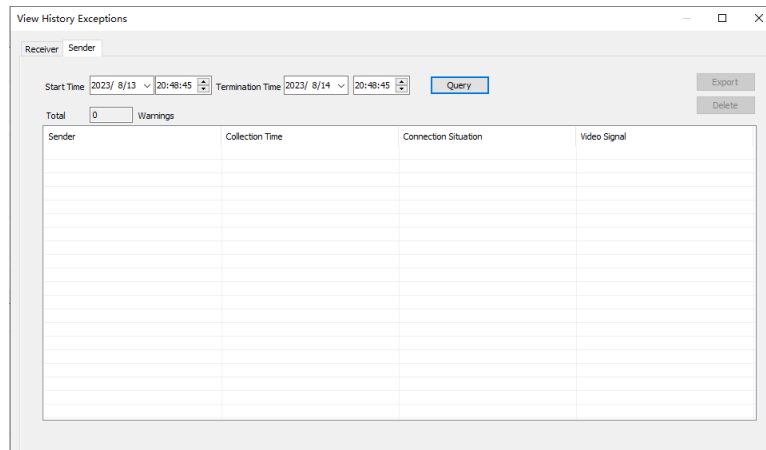

Fig 10.4.2 Exceptions from sender

View Email Log

Click **View** and then select **View Email Log**. This will display all emails sent during monitoring.

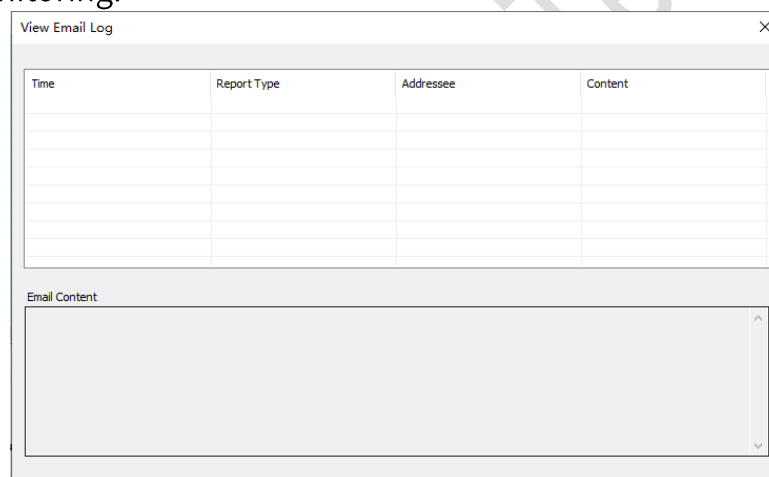

Fig 10.4.3 Email log

11. Intelligent Module

11.1 Screen Connection

Prerequisite: Go to **Screen Configuration > Receiver Parameters > Intelligent Module Settings**. Enter the desired parameter values and then save them to the receivers.

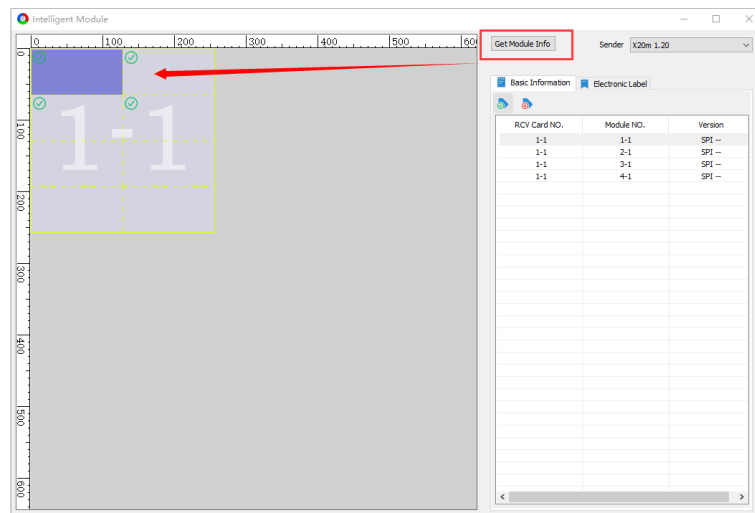

Fig 11.1.1 Intelligent module

- Get Module Info: Click this button to get the intelligent module information of the selected sender.
- Drawing area: Show the detected intelligent modules. Modules that are valid and working properly can be selected. Modules that are invalid or not working will be grayed out and cannot be selected.

11.2 Basic Information

: Click , and the icon of will appear at the top left corner of any valid module within the drawing area.

: Click , and the icon of will appear at the top left corner of any invalid module within the drawing area.

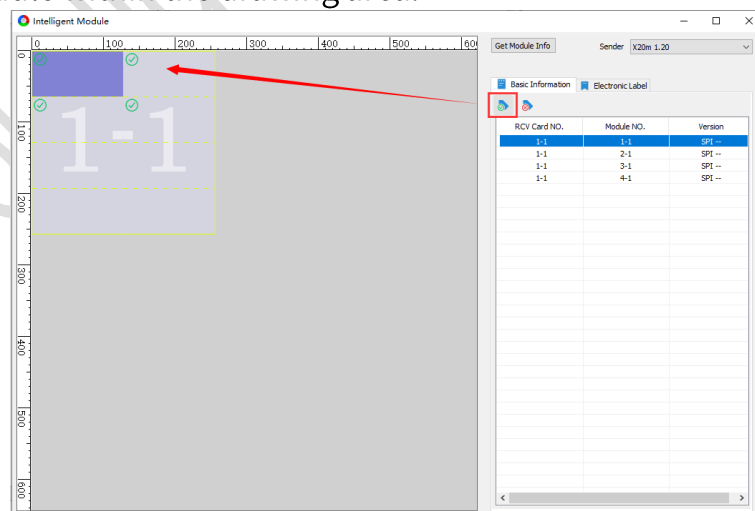

Fig 11.2.1 Mark valid module

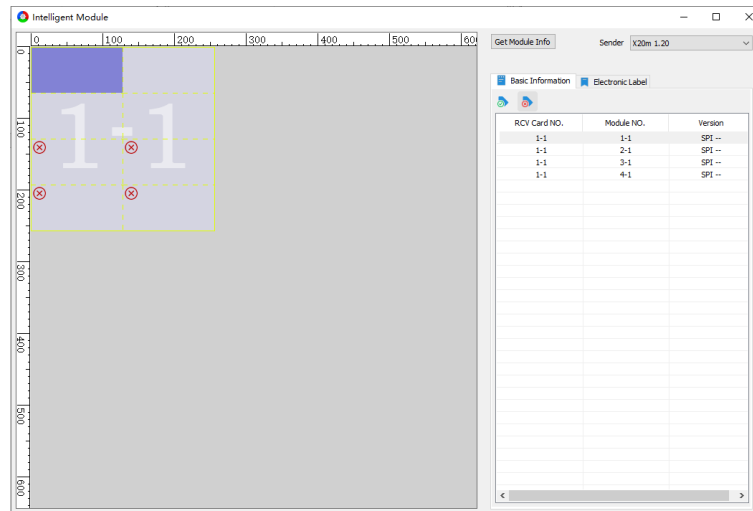

Fig 11.2.2 Mark invalid module

The list on the right side displays information of valid modules. The description of the list field is shown in Table 11.2-1.

Table 11.2-1 Description of list field

List Field	Description
RCV Card No.	Display the sender' s “Port Index – Rcv Index” .
Module No.	Display the intelligent module number set in Receiver Parameters .
Version	Display the version of intelligent modules.

11.3 Electronic Label

Click  **Electronic Label** to switch to the **Electronic Label** tab.

- Functions

: Select an intelligent module, then click the icon to import the electronic label from a local file.

: Select an intelligent module, then click the icon to export the electronic label of an intelligent module to a local file.

Delete All: Click to delete the electronic labels of all intelligent modules.

Write: Click to write the electronic label to the selected intelligent module.

Descriptions of the electronic labels are shown in Table 11.3-1.

Table 11.3-1 Description of electronic labels

Parameter	Description
Module ID	Enter an intelligent module ID.
Brightness and Color (Before Calibration)	Enter the desired brightness and color parameters before calibrating the screen.
Brightness and Color (After Calibration)	Enter the desired brightness and color parameters after calibrating the screen.
Desp	Enter a remark for the selected intelligent module.

- Electronic Labels Writing Procedures

Step 1: To import electronic labels for a module, select the module first. Then, click the **Import** icon above the table or enter the label information directly in the table, as shown in Figure 11.3.1.

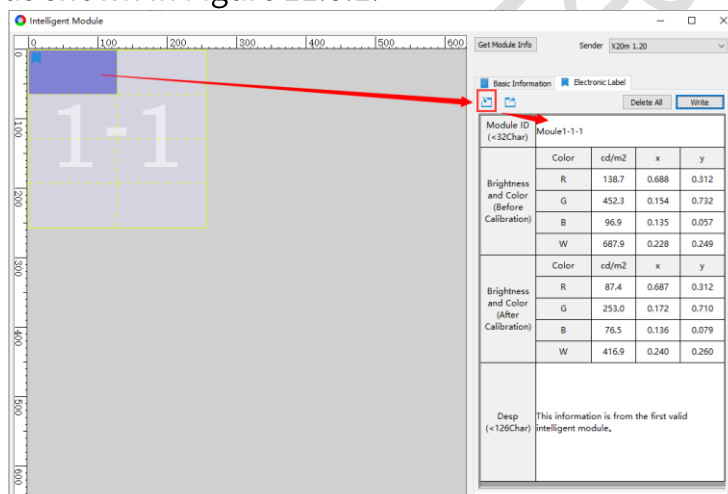



Fig 11.3.1 Import electronic labels

Step 2: Click **Write** to write the electronic label to the selected module. Once the label is written, the icon  will display at the top left of the module in the drawing area, as shown in Figure 11.3.2.

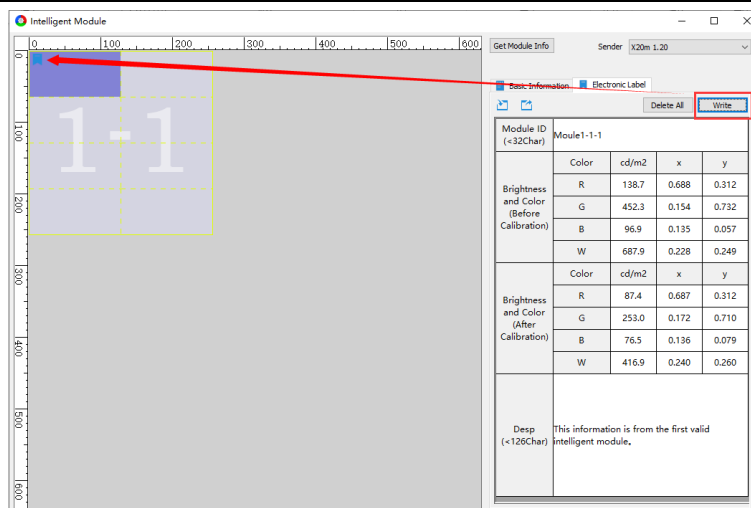

Fig 11.3.2 Write electronic labels

12. Pixel-by-pixel Detection

This feature allows for detecting if any LED beads are malfunctioning. It will display the number of red, green, and blue beads detected as error points in pixels under the **Error Points Detected** list. To use this function, you need a compatible LED cabinet and the receiver program.

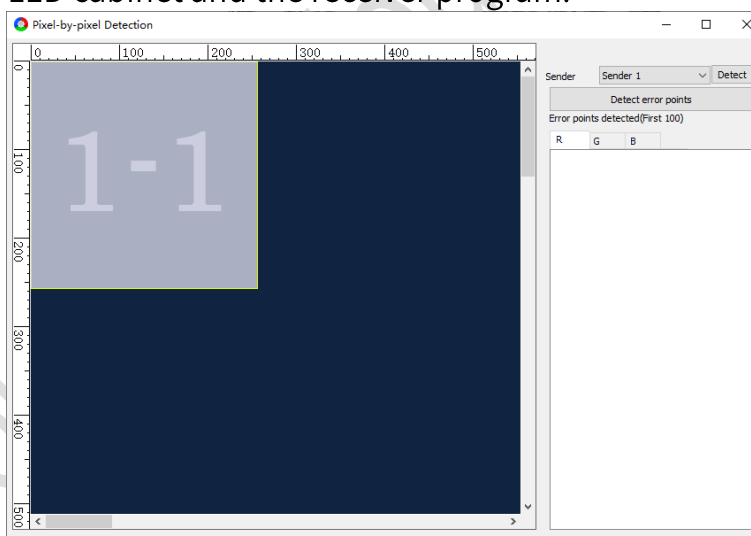

Fig 12.1 Pixel-by-pixel detection

- Detect: Detect all senders.
- Detect error points: Click this button to perform a pixel-by-pixel detection of the selected sender, and display the number of malfunctioning LED beads.
- Information area: Display the number of malfunctioning LED beads detected for the selected sender. The totals are shown under the R, G,

and B categories respectively.

- Preview area: Display the mapping diagram of the currently senders.

13. Prestore Picture

13.1 Prestore Screen Capture

- Unselect the checkbox next to **The software generates the prestore picture**. Click the **Capture** button to save the last displayed frame (still frame) as a prestore picture.
- Select the checkbox next to **The software generates the prestore picture**. Click the **Capture** button to save the picture loaded by the software as a prestore picture.

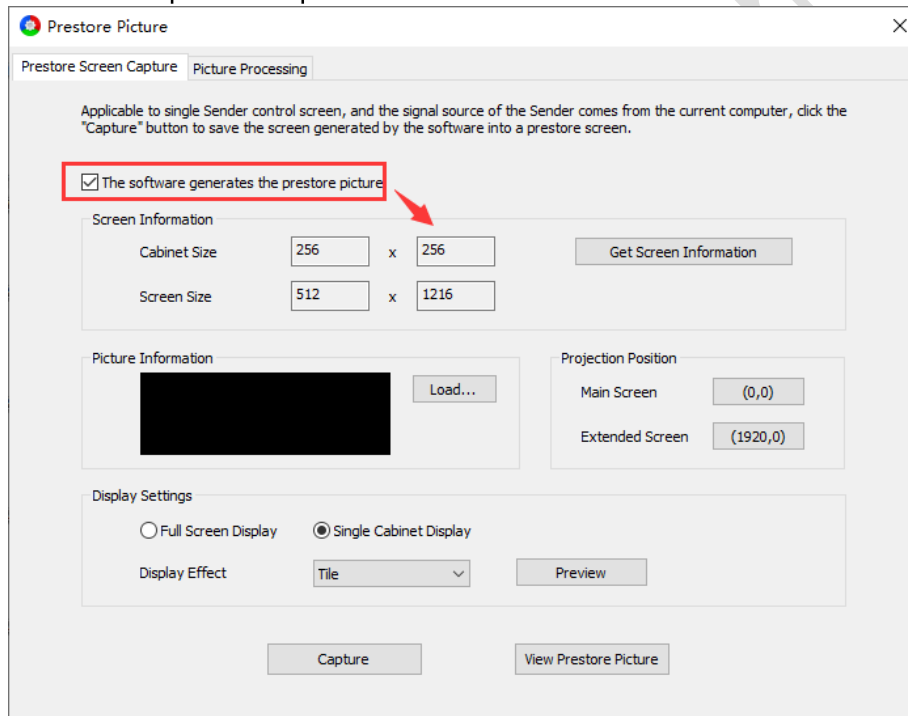

Fig 13.1.1 Prestore screen capture

Procedures

Step 1: Click the **Get Screen Information** button to view **Cabinet Size** and **Screen Size**.

Step 2: Click **Load** to load a picture to be captured.

Step 3: Choose a desired projection position. The picture will display on the corresponding area of the screen.

 Notes:

To choose where the picture is displayed:

1. Selecting **Main Screen** under **Projection Position** will show the picture on the computer' s duplicate screen.
2. Selecting **Extended Screen** under **Projection Position** will show the picture on the computer' s extended screen.

Step 4: After setting the picture display mode and effect, click **Preview** to view the picture effect.

Step 5: Click **Capture** to save the loaded picture as a prestore picture.

Step 6: Click **View Prestore Picture** to view the prestored picture on the screen.

Functions

The functions of **Prestore Screen Capture** are described as shown in Table 13.1-1.

Table 13.1-1 Description of prestore screen capture

Area	Parameter/Button	Description
Screen Information	Cabinet Size	Display the width and height of the cabinet.
	Screen Size	Display the width and height of the screen.
	Get Screen Information	Get the screen information by updating the cabinet size and screen size values.
Picture Information	Load	Load a picture from a local file. The selected picture will appear in the preview area on the left side of the interface.
Projection Position	Main Screen/Extended Screen	Switch the projection position between Main Screen and Extended Screen .
Display Settings	Full Screen Display/Single Cabinet Display	Switch the display mode of a selected picture between Full Screen Display and Single Cabinet Display .
	Display Effect	Switch the display effect of a selected picture between Tile and Stretch .
	Preview	Preview the picture' s effect at the chosen

		projection position.
Button	Capture	Save the captured picture as a prestored picture.
	View Prestore Picture	Display the prestore picture on the screen.

13.2 Picture Processing

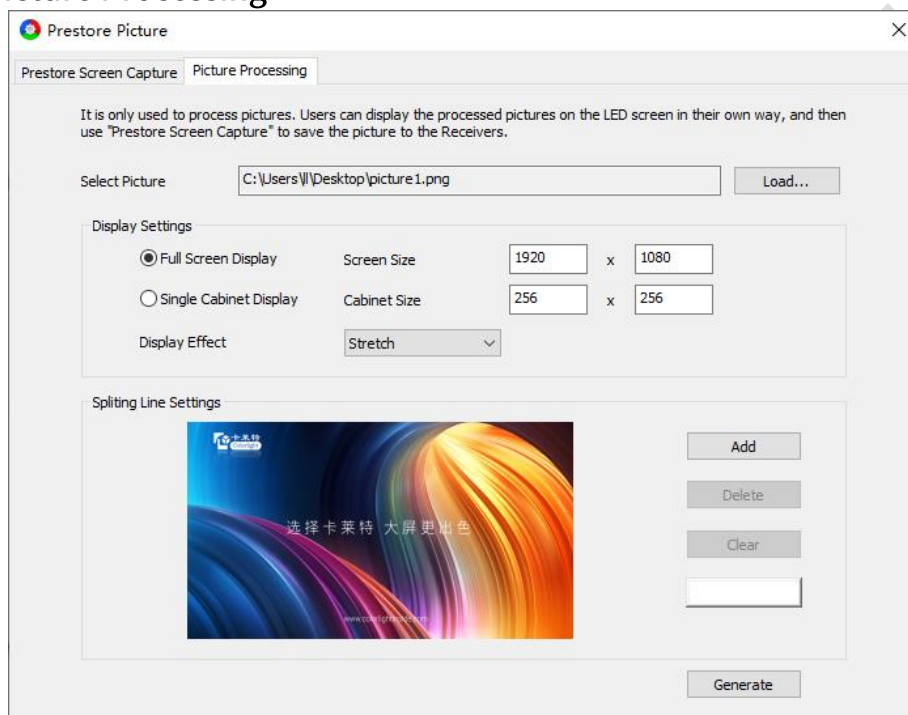

Fig 13.2.1 Picture processing

Procedures

Step 1: Click **Load** to load a picture.

Step 2: Enter the desired screen size and cabinet size. Then, choose a display mode and an effect for the picture.

Step 3: Add splitting lines where you want to divide the image.

Step 4: Click **Generate**. This will split the image along the lines you added under **Splitting Line Settings** and save the pieces to local files.

Functions

The functions of **Picture Processing** are prescribed as shown in Table 13.2-

1.

Table 13.2-1 Description of picture processing

Area	Parameter/Button	Description
Select Picture	Load	Load a picture from a local file, and its file path will display in the text field.
Display Settings	Full Screen Display/Single Cabinet Display	Switch the display mode of a selected picture between Full Screen Display and Single Cabinet Display .
	Display Effect	Switch the display effect of a selected picture between Tile and Stretch .
	Screen Size/Cabinet Size	Adjust the width and height of the screen and the cabinet.
Splitting Line Settings	Left Side Preview Area	Display the display effect of a selected picture.
	Add	Add a splitting line, and adjust its direction and position.
	Delete	Delete the most recently added splitting line.
	Clear	Clear all splitting lines.
	Splitting Line Settings	Click <input type="text"/> to select a desired color for splitting lines.
Button	Generate	Split the image along the lines you added under Splitting Line Settings and save the pieces to local files.

14. Player Mode

Go to **Screen Configuration > Device Information**, and select **Player** under **Select Sending Mode**.



Fig 14.1 Switch player mode

Main Interface

Access the main interface under **Player Mode**.

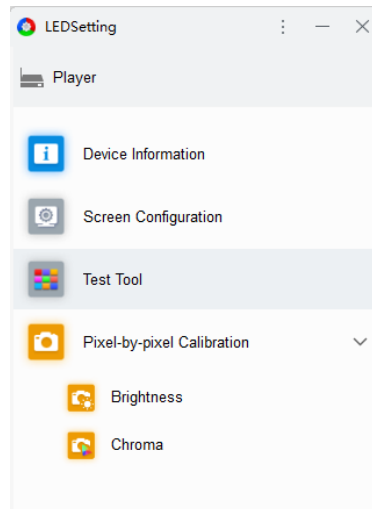

Fig 14.2 Main interface

- The main interface contains 4 default modules: **Device Information**, **Screen Configuration**, **Test Tool**, and **Pixel-by-pixel Calibration**.
- Use the **Software Module** and **Software Settings** tools to:
 1. Configure the display status of main interface modules.
 2. Arrange the order of modules displayed in the main interface.

Screen Configuration

- Device Information

Display information for all connected devices.

Type	Status/Count	Refresh	Port	Index	Type	IP	Support Chip	Network Packets	Error Packets	Run Time	HUB Type
> Termina...(USB Connected)	2		1	1	i10 16.08	0.00	MBI5153,ICN2055,MBI535	367,964,672	4	3:44:29	
			1	2	i10 16.08	0.00	MBI5153,ICN2055,MBI535	367,964,672	4	3:44:29	

Fig 14.3 Device information

- Detect Device: Click to display a list of information about the connected devices.
- List: Sender/Player information is displayed on the left side, while the receiver information is displayed on the right side. See Chapter 4 Device Information for details.

- Player Settings

: Click this icon to detect a player and refresh the interface.

Device List: When two or more players are cascaded together, all connected players will be shown in the device list. You can select a player icon to access that device and configure its settings.

For more advanced player configuration options, we recommend downloading the “PlayerMaster” software.

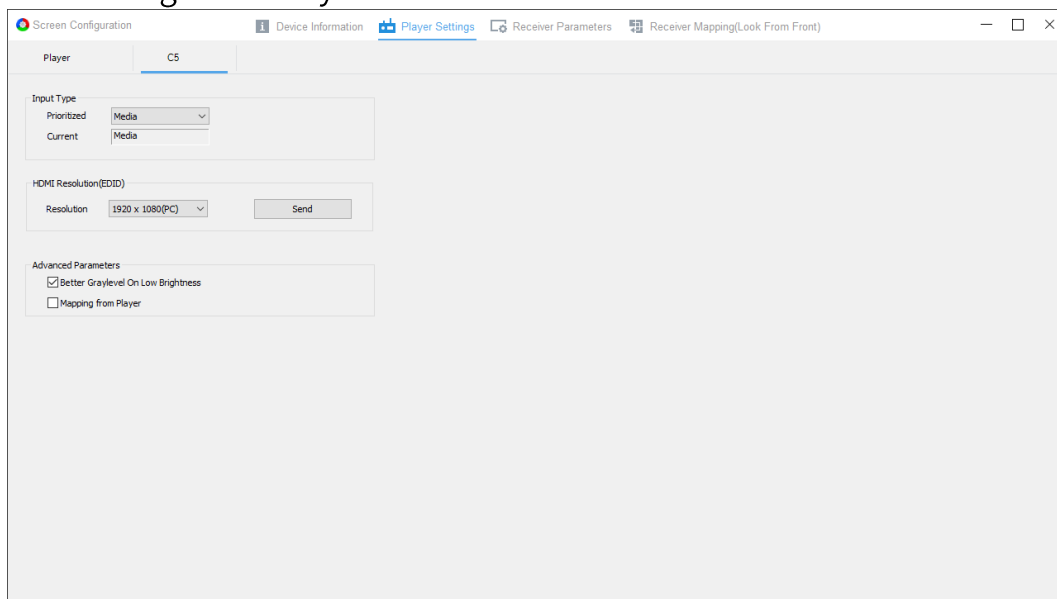

Fig 14.4 Player settings

- Receiver Parameters

When two or more players are cascaded together, select a desired device under **Player Settings**, and set its parameters in **Receiver Parameters**. Then, click the **Save to Receivers** button to apply the new parameter settings to the receiver connected to the selected player. See Chapter 6.3 for parameter configuration.

- Receiver Mapping

When two or more players are cascaded together, switch a desired device in **Player Settings**, and draw the mapping diagram in **Receiver Mapping**. Then, click the **Save to Devices** button to apply the mapping diagram to the receiver connected to the selected player. See Chapter 6.4 for drawing the mapping diagram

Statement

Copyright © 2023 Colorlight Cloud Tech Ltd. All rights reserved.

No part of this document may be copied, reproduced, transcribed, or translated without the prior written permission of Colorlight Cloud Tech Ltd, nor be used for any commercial or profit-making purposes in any form or by any means.

This guide is for reference only and does not constitute any form of commitment. Please refer to the actual products (including but not limited to color, size, screen display, etc.).

Service Phone

4008 770 775

Colorlight Cloud Tech Ltd

Official Website: www.colorlightinside.com

Head Office Address: 37F-39F, Building 8, Zone A,

Shenzhen International Innovation Valley, Vanke Cloud City,

Nanshan District, Shenzhen, China

